

NOBLE Rides disclaimer:

The information contained in this brochure is provided for general guidance only. While every effort has been made to ensure accuracy, specifications, features, designs, prices, and availability are subject to change without prior notice. This brochure does not constitute a contractual offer and should not be relied upon as the sole basis for any purchasing decision. Images are for illustrative purposes only; actual products, colors, and configurations may vary. All products and services are subject to availability and applicable terms and conditions. The company accepts no liability for any errors, omissions, or consequences resulting from the use of this brochure.



NOBLE Rides Switzerland

☎ : +41 44 974 68 79

🌐 : <https://noblerides.ch/>

✉ : info@noblerides.ch

📍 : AG Brückfeldstrasse 16 3012 Bern, Switzerland

NOBLE RIDES USA

✉ : info@noblerides.com

📍 : NOBLE Rides LLC 30 N Gould St Ste 31450 Sheridan, WY 82801

Noble Rides Catalogue

03, 2025





01

Giant Wheels

- Giant Wheel



Giant Wheel GLC-168A

The Giant Wheel GLC-168A equips with 32 capsules, while each capsule is capable for 40 people. The huge space of capsule gives it more possibilities of theming--the capsule can be decorated as a meeting room, a proposing/wedding site or a dinner place!

With 720 degrees viewing angle, capsules, 168m height, every passenger who rides the special GLC-168A will be impressed a lot for long!

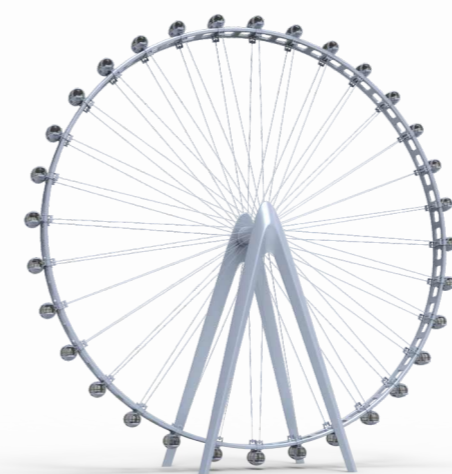

Ride Height
168m



Cabin Type
Double-ring
Capsule



Load
40 riders/cabin × 32

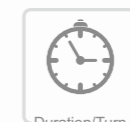

Duration/Turn
35 min/round

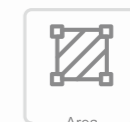

Area
160m × 80m



Installed
Capacity
520kVA



Giant Wheel GLC-139B

The Giant Wheel GLC-139B breaks the boundaries of the traditional giant wheel and combines the sightseeing giant wheel with the leisure sightseeing tower in a simple manner. 139 meters high, equipped with double-tube rim turntable, equipped with 28 large viewing cabins, the structure is majestic. The tower innovatively sets up viewing and leisure platforms, and is equipped with elevators to connect the platforms on each floor.

With 720 degrees viewing angle, 25-riders giant capsules, 139m height, every passenger who rides the special GLC-139B will be impressed a lot for long!



Ride Height
139m



Cabin Type
Double-ring
Capsule



Load
25 riders/cabin × 28



Duration/Turn
32min/round

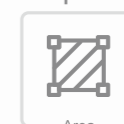

Area
136m × 100m

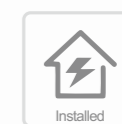

Installed
Capacity
480kVA



Giant Wheel GLC-128B

GLC-128B is a giant wheel specially designed for landmark projects. Equipped with 42 cabins with each for 6 riders, it measures 128m, and integrates programmable LED lighting on the spokes, tall and attractive enough to be a landmark for most of the cities.

GLC-128B is a great and iconic installation for urban investors.



Ride Height
128m

Cabin Type
Square Cabin

Load
6 riders/cabin × 42

Duration/Turn
25.1min/round

Area
120m × 70m

Installed Capacity
200kVA

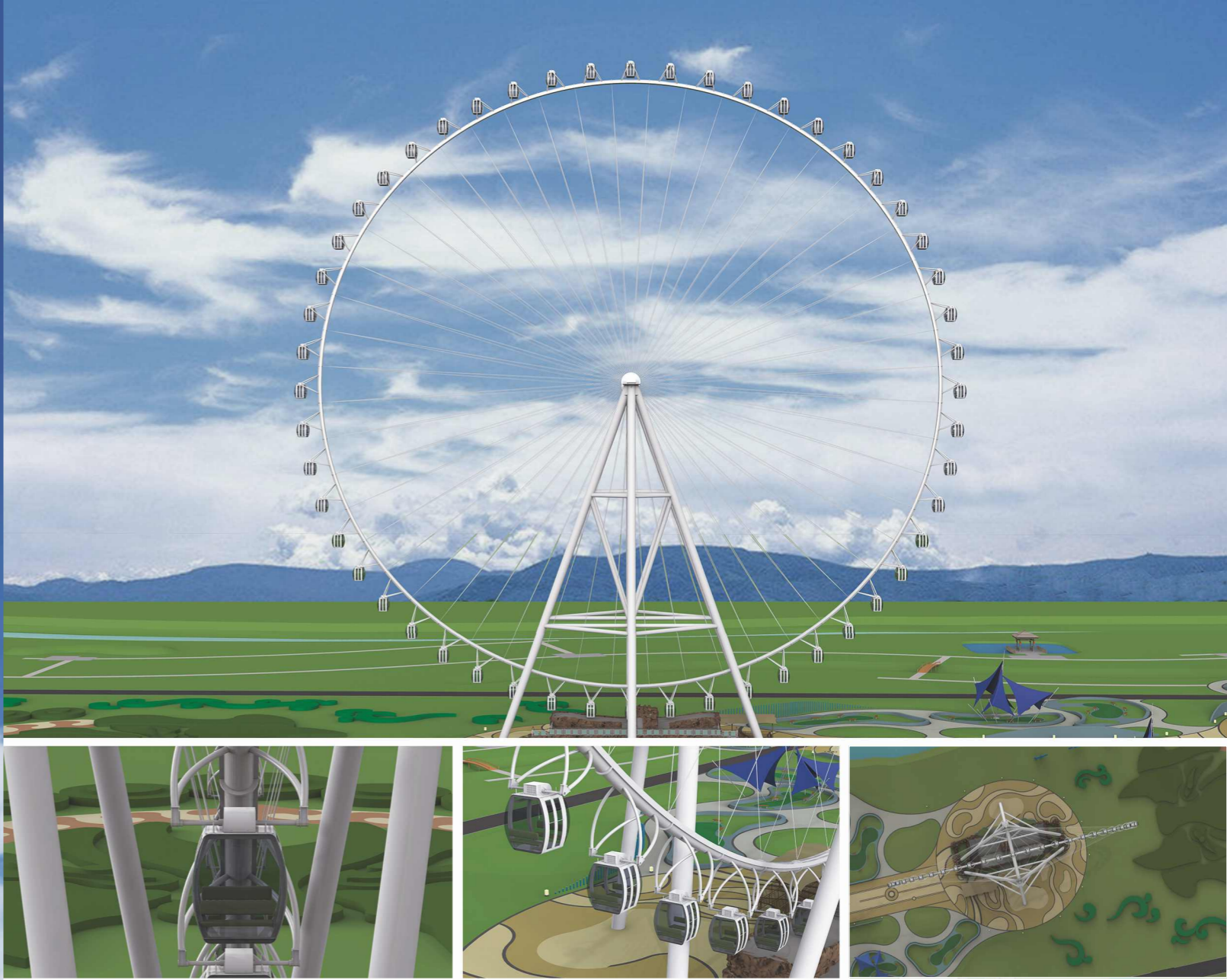

Giant Wheel GLC-108A

Giant Wheel GLC-108A adopts an innovative single-pipe rim turntable with spoke design and a six-column structure, which is innovative and stable. The gondolas are suspended on the support frame of the turntable, and the shape is magnificent. 52 transparent gondolas equipped with ACs are attached to the Giant Wheel. When rotating, the view can be seen within a 20-kilometer radius. You can enjoy a 360-degree visual sight in a comfortable viewing gondola and overlook the city scenery.

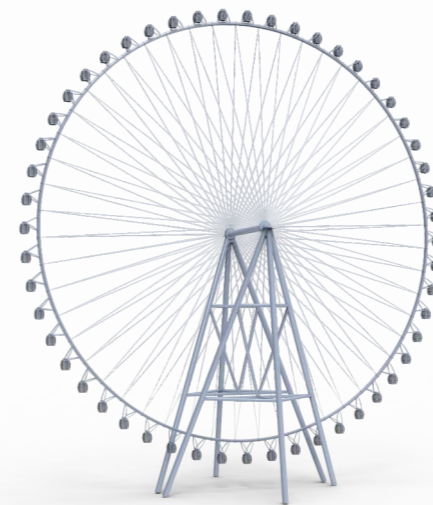

Ride Height
108m



Cabin Type
Square Cabin



Load
6 riders/cabin×52



Duration/Turn
26.7min/round



Area
105m×61m



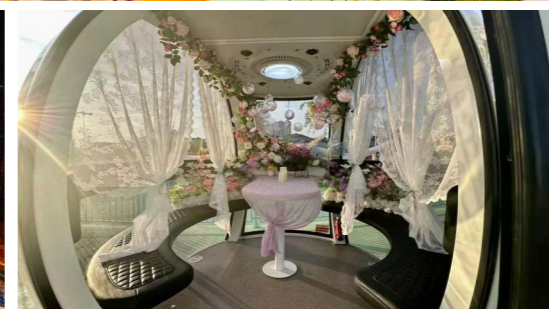

Installed Capacity
180kVA



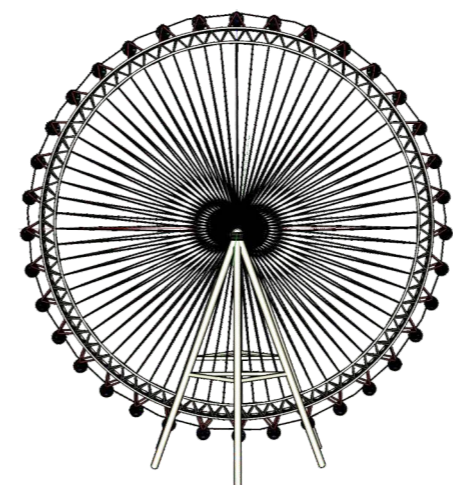

Giant Wheel GLC-88A

GLC-88A is a classical Giant Wheel with 36 gondolas. Designed at a proper height of 88 meters, it stands tall enough to be regarded as a landmark, yet not too tall to jar with its surroundings. There are some key design concepts of GLC-88A: 6 columns, 3-pipe rim, ball gondolas, wire-rope, etc. All of these special elements make GLC-88A a unique and different Ferris Wheel.





 Ride Height
 88m



 Cabin Type
 Ball Cabin

 Load
 6 riders/cabin × 36

 Duration/Turn
 17.2min/round

 Area
 87m × 31m

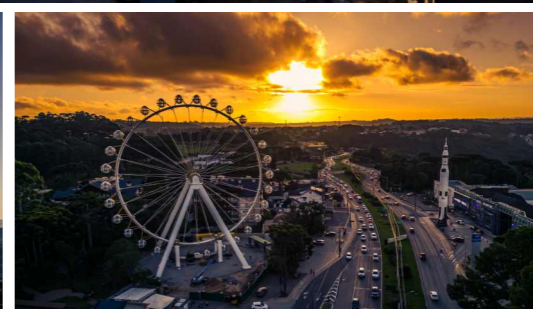
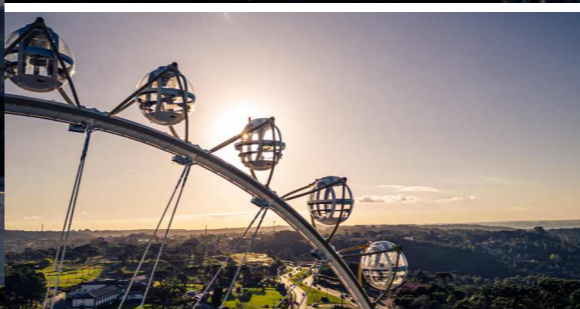
 Installed Capacity
 130kVA



Giant Wheel GLC-52C

Giant Wheel GLC-52C, a much more special and first-of-its-kind model in the market. Elegant 4 columns, simple single pipe rim, round cabins, wire-rope spoke design, all of these, are integrated in the novel Giant Wheel GLC-52C!

The wheel's diameter measures 49.5m. When installed, the overall height is around 52 meters. The drive rim of the wheel is supported by 4 strong columns, with 2 on each side. 30 cabins are suspended on brackets evenly distributed around the drive rim. Each cabin decorated in a classy fashion, pivots steadily under gravity as the wheel rotates.

Minimalistic and iconic, GLC-52C is a great installation for property developers.





 Ride Height
 52.4m



 Cabin Type
 Ball Cabin

 Load
 6 riders/cabin × 30

 Duration/Turn
 10.2min/round

 Area
 53m × 29m

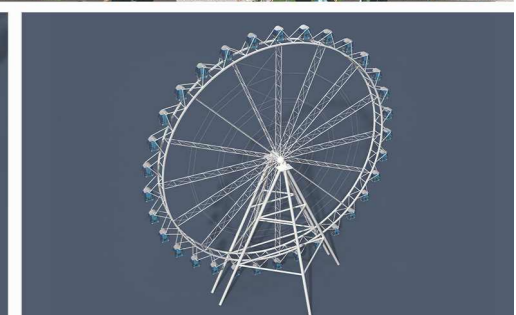
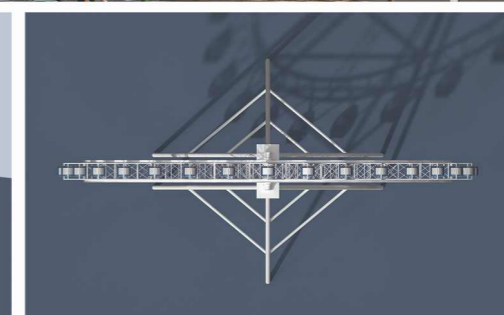
 Installed Capacity
 120kVA



Giant Wheel GLC-62B



GLC-62B, the wheel's diameter measures 59.4m. Two giant tower supports, one on each side, prop up the huge wheel. This Ferris wheel adopts steel cables as spokes that connect the circular rim to the spindle. 36 cabins are suspended on brackets evenly distributed around the drive rim. Each cabin, decorated in a classy fashion, pivots steadily under gravity as the wheel rotates. Minimalistic and iconic, GLC-62B is a great installation for property developers.



Ride Height

61.8m



Cabin Type

Square Cabin



Load

6riders/cabin × 36



Duration/Turn

15.6min/round



Area

38m × 63m



Installed Capacity

95kVA

Giant Wheel GLC-50A



Giant Wheel is no longer just an attraction for the amusement park. It's a new way to overlook the whole city, which could come up in the commercial complexes, tourist attractions, riverbanks etc, to be the entertainment center and symbol of the city. Our 50m-high Giant Wheel is very strong in a steel-frame structure supported by 2 triangle towers with 32 standard closed gondolas loading 4 passengers for each. The Giant Wheel GLC-50A is able to entertain around 600 passengers per hour.



Ride Height

49.8m



Cabin Type

Square Cabin



Load

4 riders/cabin × 32

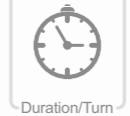

Duration/Turn

10min/round



Area

49m × 27m



Installed Capacity

85kVA









Giant Wheel GLC-42D



The Giant Wheel GLC-42D, with spoke-type turntable, makes it lighter and more flexible. The height of the wheel is 42 meters, at a proper height with excellent cost performance.



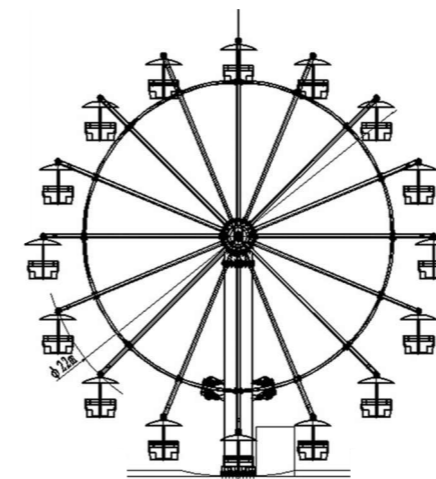

Twenty gondolas(each gondola can carry 6 riders) evenly installed on the turntable, rotating at the speed of 10.2 minutes per round, resulting in its high operational loading efficiency.

 Ride Height 41.8m	 Cabin Type Square Cabin	 Load 6 riders/cabin × 20
 Duration/Turn 10.2min/round	 Area 42m × 22m	 Installed Capacity 85kVA

Giant Wheel GLC-25A



GLC-25A Wonder wheel is a novel wheel developed by Jinma Rides, with 16 open gondolas and fabulous design in ocean theme. The big capacity of 64riders at 25-meter height is good for the family park and children's park.

 Ride Height 26.5m	 Cabin Type Basket Gondola	 Load 4riders/cabin × 16
 Work Speed 7min/round	 Area 26m × 12m	 Installed Capacity 10kVA



02

Water Rides

- Chute Ride
- Raft Ride
- Warship



Chute Ride JL-30D

Chute Ride JL-30D is a thrilling water ride suitable for a land or water park. A gondola loaded up with excited riders is chain-lifted up to the 30m-high lift hill, from where it slides smoothly along the overhead trackway for a while, giving riders a moment of peace to visually indulge themselves with park scenery nearby and natural landscapes far away.

The peak of the ride comes when the gondola charges downwards into a water pond along a sharp slope, crashing out thousands of waves and splashes. It is a perfect hot summer ride to give passengers some wet time.



Ride Height

30.8m



Track Height

30m



Max Running Speed

90km/h



Load

20 riders/boat × 2



Area

64m × 142m



Installed Capacity

280kVA



Chute Ride JL-26R

JL-26R is a chute ride that features turntable rotation, bumpy forwarding, bumpy rearwarding and splashdown. The adoption of the turntable significantly reduces the ride's turning radius, thus less land is required to lay out the entire attraction. The ride has a lift hill that is able to elevate the gondola up to 26 meters high, from where fun and thrill really begins.

As a bonus, media and effects can be incorporated into the ride section after the intense splashdown. May you get amazed and dazzled. We customize the ride's track layouts to best fit the park's land features.



Ride Height
28m

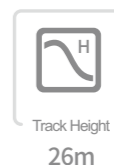

Track Height
26m

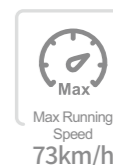

Max Running Speed
73km/h

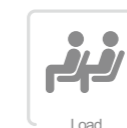

Load
20 riders/boat × 5



Area
122m × 184m



Installed Capacity
380kVA



Chute Ride JL-26D(B)

JL-26D is a thrilling chute ride running on an elevated trackway. With the incorporation of a number of fun elements, it is a great water ride in a land park for hot summer seasons. The ride journey begins as the loaded gondola climbs up to the peak of the lift hill. Starting from an elevation of 28 meters, the gondola proceeds traveling slow and smooth, allowing riders time to savor the spectacular scenery that the park and the neighborhood have to offer. Thrills max up as the gondola eventually plunges into a body of water, crashing out waves and splashes. We customize track layouts to best fit the park's land features. Every installation is unique and fun!

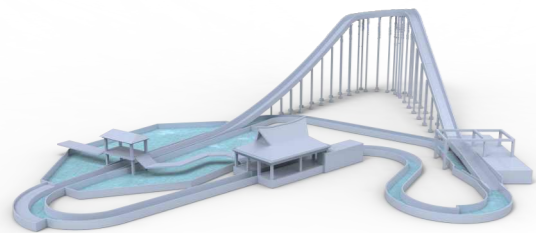

Ride Height
28m



Track Height
27.7m

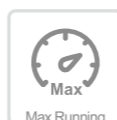

Max Running Speed
76km/h



Load
20 riders/boat × 4



Area
97m × 114m



Installed Capacity
280kVA

Chute Ride JL-20A

If you ever get the chance, try this ride out. It is just amazing! JL-20A ride is totally a water maze construction that features treacherous waterways packed with elevations, back-dive, shifting and splashdowns. With sections combined with lighting, media projection, and audio effects, it creates an immersive ambience that enhances the adventurers' overall experience. It is a long journey with lots of tunnels to get through. Thrilling and exciting, the ride allows passengers no time to get bored. So cape up and hold each other's hand tight. Let's ride it out!

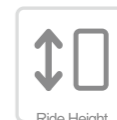
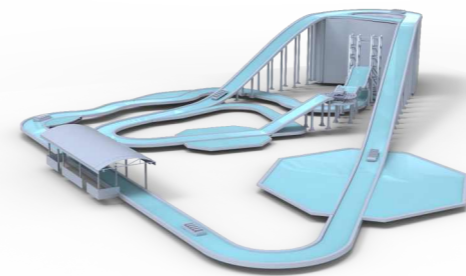

Ride Height
20.8m

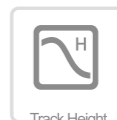

Track Height
20m

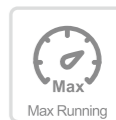

Max Running Speed
66.3km/h



Load
20 riders/boat × 10

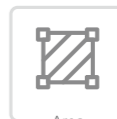

Area
170m × 90m



Installed Capacity
660kVA



Chute Ride JL-18A

The Chute ride is a summertime love that visitors won't miss at a land park. Ascending up to 18m high, onboard passengers embark on a journey full of suspense and surprise. JL-18A features two rotating platforms that orient the boat in a way so that a minimum turning radius can be achieved, which means less land usage. It also boasts backward coasting along the overhead section between the two platforms.

Seated and secured with a lap bar in a boat with a 20-rider capacity, fun-loving passengers rock and roll, dip, hump along the water ride's trackway, and eventually thrust into the waters of finality.

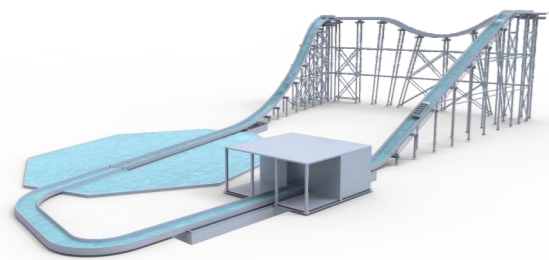

Ride Height
18.8m

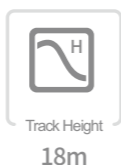

Track Height
18m

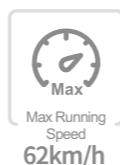

Max Running Speed
62km/h

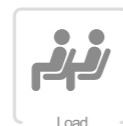

20 riders/boat x 2



Area
107m x 71m



Installed Capacity
250kVA

Chute Ride JL-15L

Chute Ride JL-15L is a simple and fun water ride. A gondola with 20p capacity is lifted up to 16m high, then it is released and coasts idly along the overhead track for a while to calm down and delight the passengers. When guys are properly stirred up, heavy thrills kick in. The gondola runs over a cliff and plunges at a high speed into a water pond at ground level. It is all about splashes, waves and happy time.

This chute ride can be a great installation for any land park seeking to introduce something wet and summery.

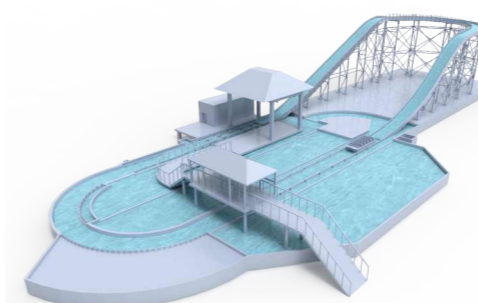

Running Height
15.8m



Track Height
15.7m

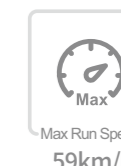

Max Run Speed
59km/h



20 riders/boat x 2



Area
100m x 40m



Installed Capacity
200kVA

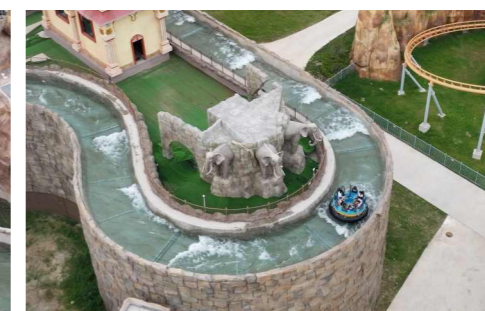

Raft Ride FL-8H

FL-8H, a novel raft ride. It is an innovative water ride which combines multiple elements into one ride, such as lifting, diving, rapid turning, water gunning and for sure the sightseeing!

Through indoor theming and interaction with media projections along the route, FL-8H can be one of the major immersive rides in any theme park!

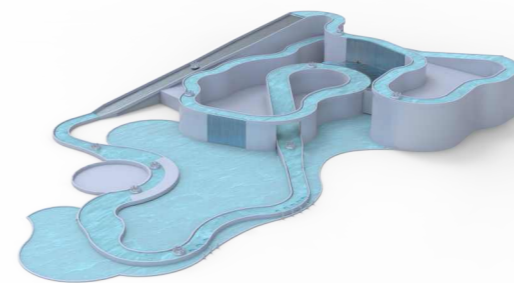

Load
8 riders/boat × 12



Elevation
16.3m



Area
140m × 85m



Installed Capacity
2500kVA



Raft Ride FL-8J

FL-8J, a novel raft ride. It is an innovative water ride which combines multiple elements into one ride, such as lifting, diving, rapid turning, water gunning and for sure the sightseeing!

Through indoor theming and interaction with media projections along the route, FL-8J can be one of the major immersive rides in any theme park!

One ride, more possibilities; one journey, more experience!

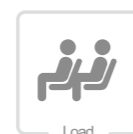
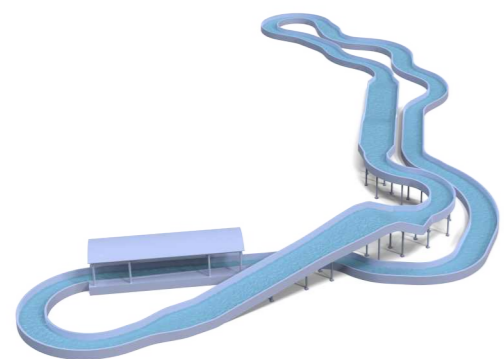

Load
8 riders/boat

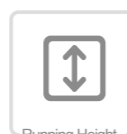

Running Height
7.8m

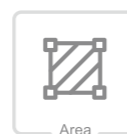

Area
3400m²



Installed Capacity
780kVA

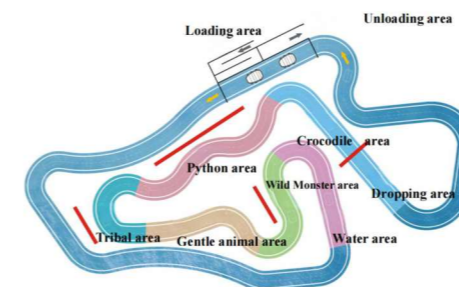

Media Raft Ride PLH-12A

The Media Raft Ride PLH-12A is set in a tropical forest setting, this raft ride attraction is built to deliver a happy jolly adventure to our boat riders. By integrating multi-media projections and lighting effects into the elaborately crafted theming, the attraction simulates the most treacherous weather conditions that one can encounter in a real tropical forest. 420m boating route is packed with scenic beauty, and loads of awes and surprises, guaranteeing a unique and memorable boating experience for guests of all ages.

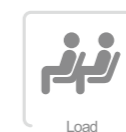

Load
12 riders/boat × 20

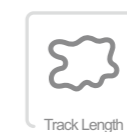

Track Length
420m

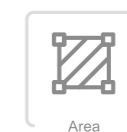

Area
Depending on the site



Installed Capacity
200kVA



Raft Ride FL-6D

With the addition of a vertical lift into the conventional raft riding, FL-6D stands out proud.

The vertical lift elevates the raft to the overhead waterway up to 12.4m high. With the working of gravity and water flow, the fun for roughing a raft really begins. It is a water ride no park visitors will skip.

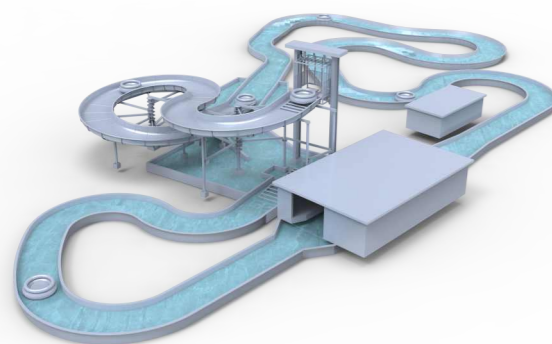

Load
6 riders/boat × 8



Running Height
12.4m



Area
10m × 120m



Installed Capacity
630kVA

Water Warship SSC-8B

Warship SSC-8B is a highly interactive water ride. Driven by the propeller, the ride's ship cruises in the lake along the track route. With the load capacity of 8 riders, the ship is geared up with equal number of badass water blasters. In this lawless ocean, no rule of engagement shall apply. Gunslingers, just aim and blast any living being if you feel like to. And don't spare those on shore observers. The ride layout can be customized per the site conditions. Ships can be customized per the theming.

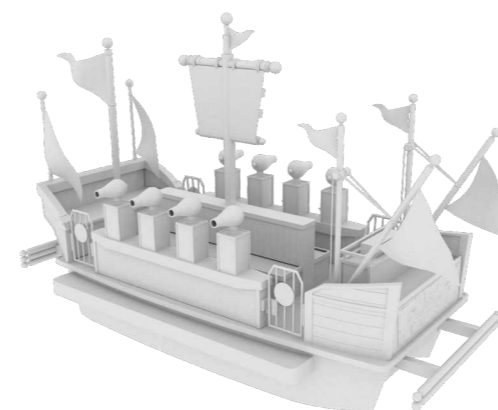

Load
8 riders/boat × 10



Run Speed
0.8m/s



Area
Depending on the site



Installed Capacity
20kVA

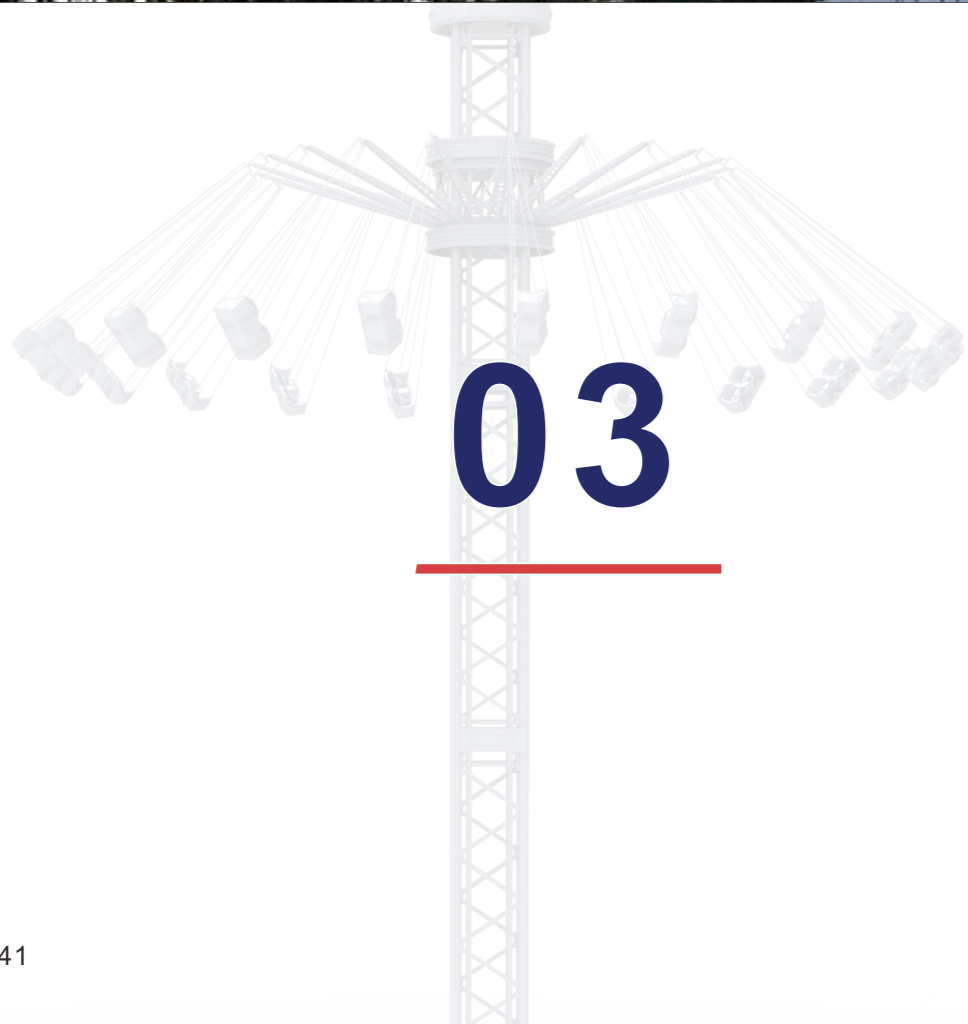

03

Tower Rides

- Jumping Frog
- Spinning Drop
- Launch Tower
- Tower Challenger
- Observation Tower
- Air Ship
- Sky Ring



Sky Ring XKH-100A

The Sky Ring is an observation tower ride. The 65m high tower features a huge doughnut vehicle with the load capacity up to 100 visitors. The rotating vehicle offers a wide view, enabling visitors to fully enjoy the cityscape. The vehicle is designed with 2 access doors to reduce loading/offloading time.

Minimal and futuristic, Sky Ring stands out tall to draw all visitors to get to know and then fall in love with the city.

<p>Ride Height 65m (Excluding lightning rod)</p>	<p>Hoisting Speed 0.5m/s</p>	<p>Revolution Speed 0.6rpm</p>
<p>Load 100p</p>	<p>Area 15m × 18m</p>	<p>Installed Capacity 320kVA</p>

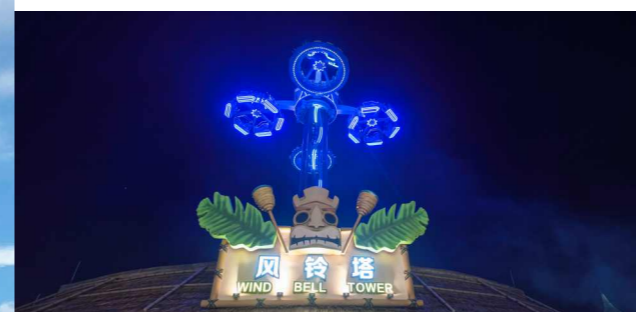

Sky Screamer FXT-56A

The Sky Screamer combines 2 types cabin in 1 ride, one is rotating cabin and another is swinging cabin, to achieve diversified sliding and swinging experience, providing passengers with a novel and exciting experience.



Ride Height
34.8m

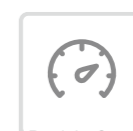

Big arm rotating speed:8rpm
Small arm rotating speed:15rpm



Hoisting Speed
0.8m/s

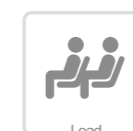

Load
56p

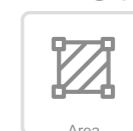

Area
24.3m×22m



Installed Capacity
250kVA



Sky Screamer XZT-36A

XZT-36A is a smaller model Sky Screamer developed by Jinma Rides, it combines 2 types cabin in 1 ride, one is rotating cabin and another is swinging cabin, to achieve diversified sliding and swinging experience, providing passengers with a novel and exciting experience.



Ride Height
36.2m



Revolution Speed
Big arm rotating speed : 8rpm
Small arm rotating speed : 15rpm



Hoisting Speed
0.8m/s



Load
36p



Rotating Diameter
13.6m



Installed Capacity
175kVA



Air Ship HZY-72A

6 suspended gondolas are flying in the air with each carrying 12 passengers. Total 72 riders can be accommodated to enjoy the dynamic mid-air experience in one ride cycle!

HZY-72A is 25-meter-tall tower ride. When lifted to the highest position, the gondolas spin and swing at an elevation of 9.4m. Eye-catching and heart-popping, it is a novel-designed tower ride that parks may consider to have.



Ride Height 28.2m	Running Height 9.4m	Revolution Speed 6.2rpm
Load 12 riders/Chair × 6	Area φ48m	Installed Capacity 250kVA

Helicopter TST-30A

TST-30A is family sightseeing tower ride, themed as a helicopter to create air moment for passengers. It is a ride that definitely enchants our little friends. As the helicopters travel up and down, little pilots gaze out of the cabin, checking the whole world out there.

Five helicopters are suspended and lifted via steel cables, thus they rock a little bit, adding kicks of thrill to otherwise a smooth journey.

It is a lovely ride that kids definitely adore and park owners must have.



Ride Height 32m	Hoisting Speed 1m/s	Revolution Speed 3rpm
Load 6 riders/cabin × 5	Area φ15.5m	Installed Capacity 200kVA



Parachute TST-24A

Parachute TST-24A is themed as a tower one may only find on a fairy land, it is a ride that definitely enchants our little friends. As the cabins climb up or go down, little parachuters gaze out of the cabin, checking out the whole world out there.

Six cabins are suspended and lifted via steel cables, thus they rock a little bit, adding lots of thrill to a smooth ride experience.

 Ride Height
 23.7m

 Hoisting Speed
 1m/s

 Running Speed
 1m/s

 Load
 4 riders/cabin × 6

 Area
 17m × 13m

 Installed Capacity
 40kVA



Tower Challenger FXT-42A

Tower Challenger is a smooth fun ride. Swirling around the 58m-tall tower, passengers travel steadily up to an altitude of 46 meters. Thrills intensify as it goes up and up. But do not overreact or panic, it is just meant to be a smooth ride meant for you to enjoy.

There are 21 double-seated cabins. Each cabin is suspended onto a mechanical arm via steel cables. 21 arms are assembled onto a central carousel that rotates and travels vertically along the column.

"High in the air, hear out the wind whisper. If a heart itches a bit, squeeze the loving hand tight"





 Ride Height
 58m



 Hoisting Speed
 1m/s

 Revolution Speed
 10.4rpm

 Load
 2 riders/chair × 21

 Area
 φ29.5m

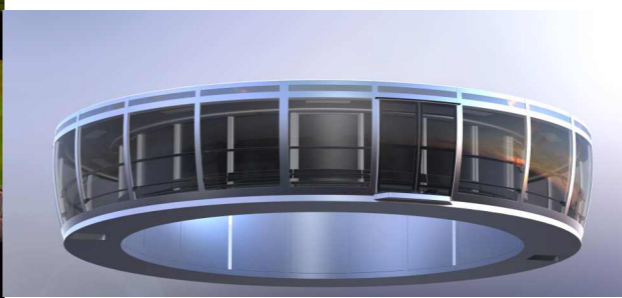
 Installed Capacity
 200kVA



Tower Challenger FXT-36A

Tower Challenger is a scaled-down version of FXT-42A. The ride stands 35 meters high, with 18 double-seated cabins. It is a tower ride popular with juniors or adults who are a little bit of afraid of height but anyhow face up to the challenge when their loved ones are present.

Secured in seat, passengers are spread outward as the rotation accelerates. Just close your eyes, spread our arms and imagine you were a bird flying. It is a freedom from the natural law.

Elaborately decorated, it is just like a monument that draws good folks to the park. Fitted with programmed led lighting, it adds to the park a splendid night view as well.



Ride Height
34.5m



Running Height
27.1m



Revolution Speed
10rpm



Load
2 riders/chair×18



Area
φ28m



Installed Capacity
200kVA

Observation Tower GJT-60A

GJT-60A is an observation tower. The ride is 65m high with the load capacity of 60p.

After passengers board the tube-shaped carrier, it rises in a slow pace while rotating. when the peak is reached, it stays for a while and then slowly descends and starts returning to the ground base.

Steady and smooth, it offers passengers a reliable vehicle for some great sightings.

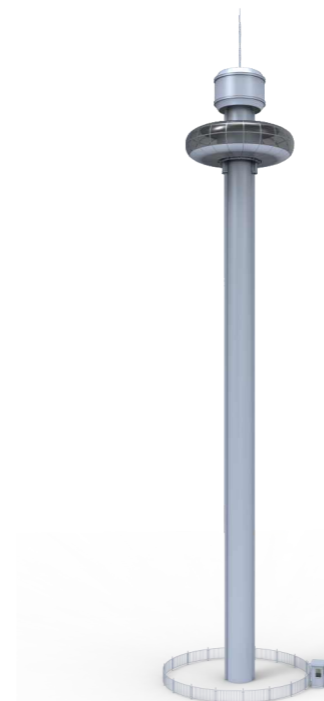

Ride Height
64.9m



Hoisting Speed
1m/s



Running Speed
1.4m/s



Load
60p



Area
16m×15m



Installed Capacity
190kVA

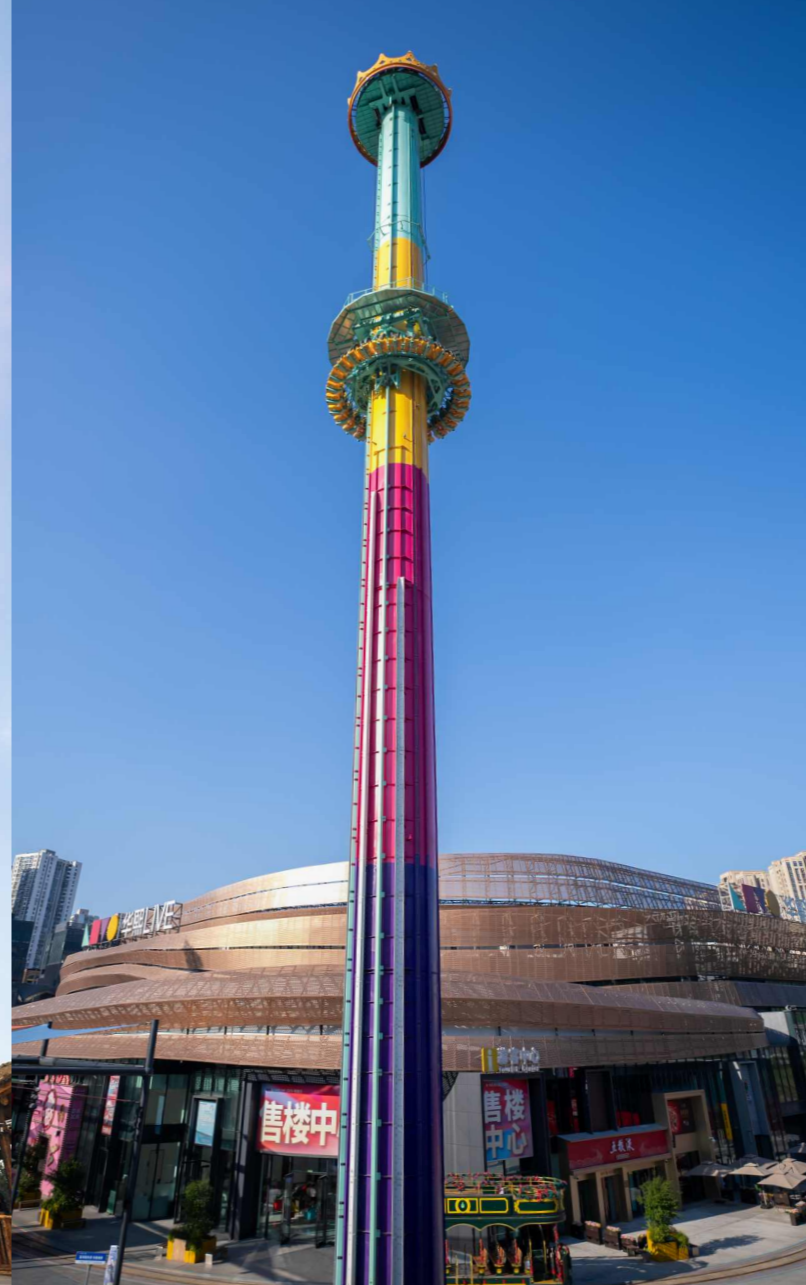

Twins Launch Tower TKS-32B

TKS-32A is a twin tower ride for die-hard thrill seekers. Standing 57m tall, it consist of two towers, one launching and another free falling. The passengers can choose to experience one of tower, or both of them for difference riding experience.

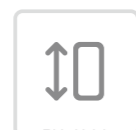

Ride Height
57m



Run Speed
Launching:13.3m/s
Dropping:17.8m/s



Running Height
44m

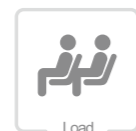

Load
32p

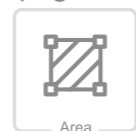

Area
23.8m × 10.9m



Installed Capacity
225kVA

Mega Drop ZYT-28B

As the name indicates, Mega Drop ZYT-28A offers passengers a few precious seconds of freedom, a total freedom from gravity.

The freefall ride stands 65m tall. A hoisting frame locks onto the carousel which is mounted with circular seating around. Then it starts to lift the carousel in a slow and controlled pace up to 55m high from where the big drop unfolds as the locking device is disengaged.

Balanced with tranquil sight-seeing pleasure (up) and extreme freefall sensation (down), this tower ride is always a star installation in parks that we have worked with.



Ride Height
63.7m



Run Speed
22.7m/s



Revolution Speed
3.3rpm



Load
28p

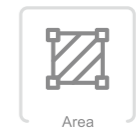

Area
12.2m × 11.5m



Installed Capacity
330kVA



Launch Tower TKS-20A

TKS-20A is a tower ride for die-hard thrill seekers. Standing 48m tall, it shoots passengers up to 38m high in an instant. During the ride cycle, passengers are able to experience lots of airtime and heaviness that positive Gs impose.

The ride is programmed to perform shoots, dips, smooth rises and big drops, delivering maximum sensations that will linger for a very long period of time...

Launch Tower TKS-20A is able to accommodate 20 passengers, who are contained and secured with over-shoulder restraints.



 Ride Height 48m	 Hoisting Speed 8m/s	 Running Height 40m
 Load 20p	 Area 23.2m x 12.2m	 Installed Capacity 180kVA







Spinning Drop TKS-16C

TKS-16C is one of these interesting freefall rides. The slim tower stands about 25 meters tall. Circular seating mounted on a spinning cabin slides up and down the tower body. The spinning cabin adds extra spatial motion to the otherwise plain vertical movements.

Vertical motion of the ride is powered and controlled via the hydraulic system. Thus passengers are able to have a smoothly thrilling ride experience.

Spinning Drop comes with a seating capacity of 16 people with each seat fitted with a shoulder restraint device.



 Ride Height 21.4m	 Run Speed 6m/s	 Running Height 17.5m
 Load 16p	 Area 9.2m x 10.7m	 Installed Capacity 120kVA

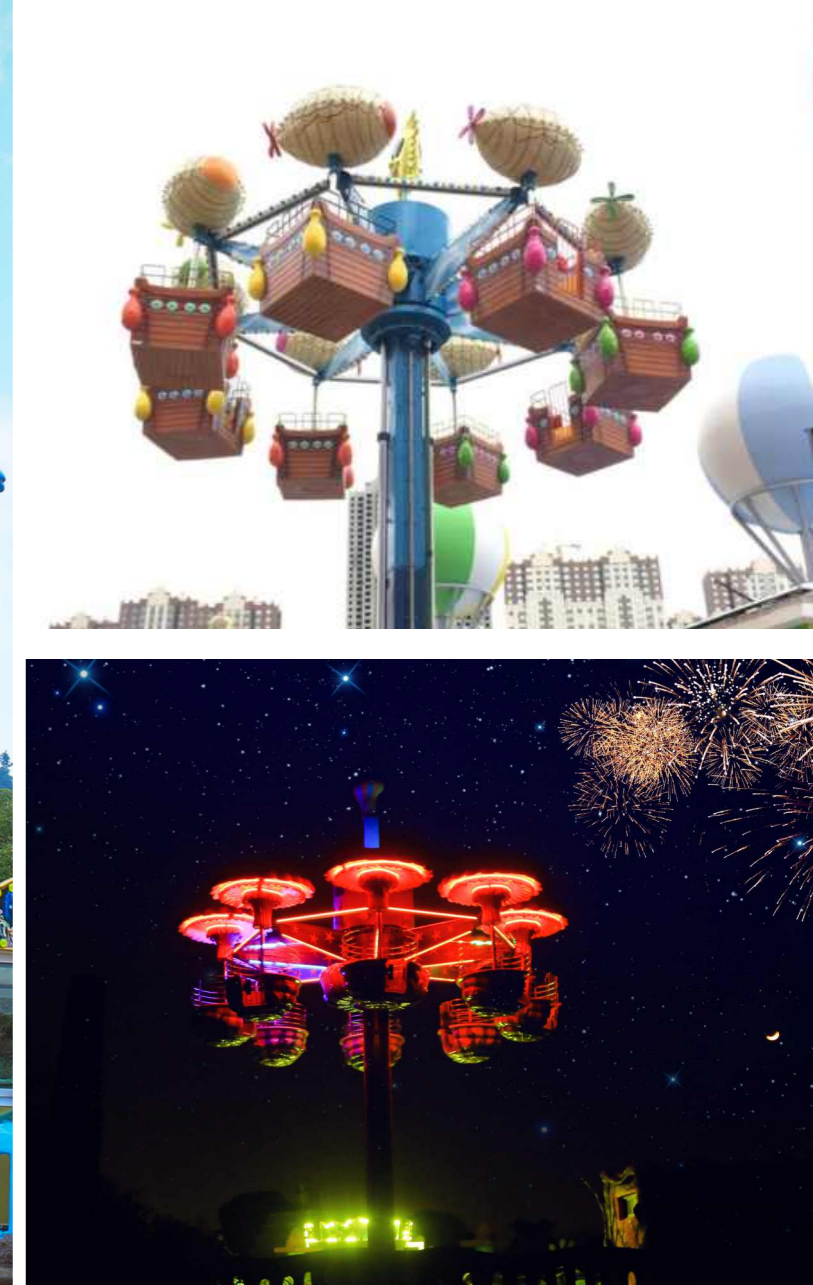
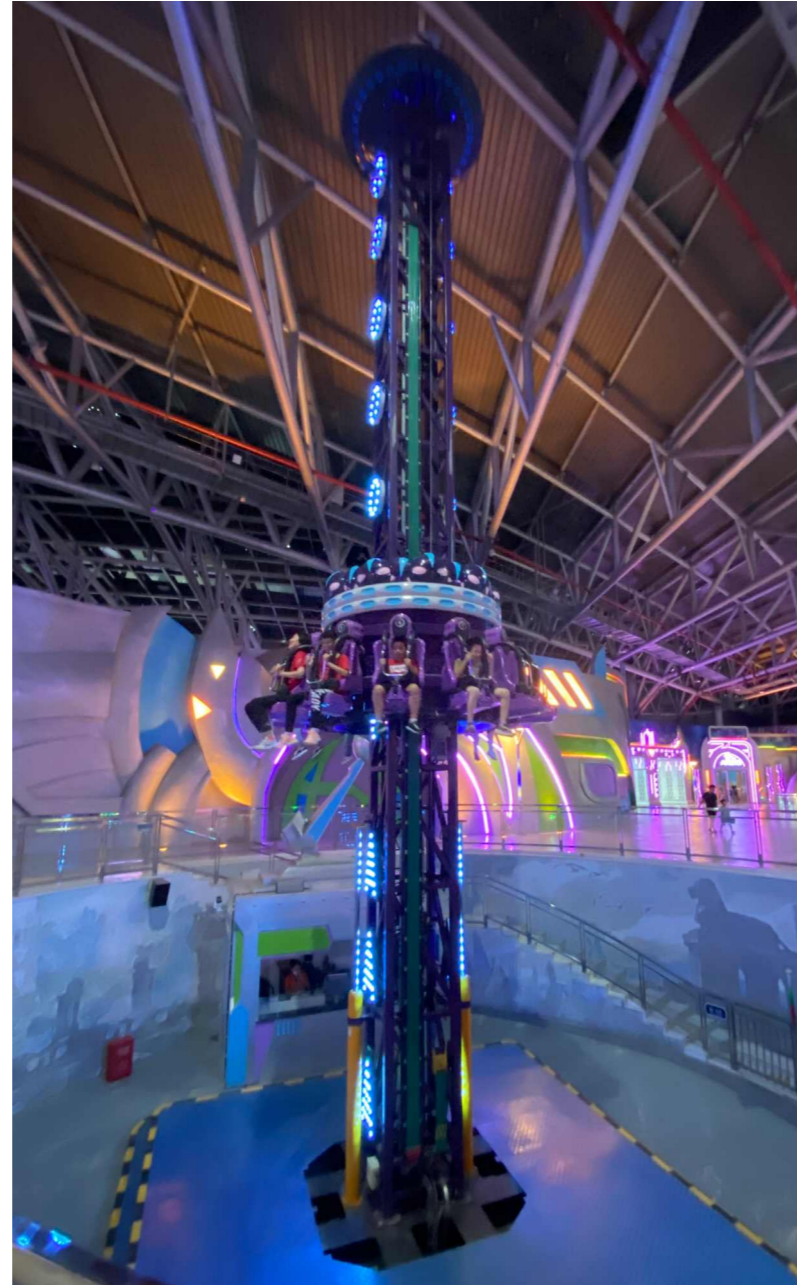



Spinning Drop QWT-12D

QWT-12D is one of interesting freefall rides for families. This slim tower stands 15.5 meters tall. Circular seating mounted on a turntable slides up and down the tower body. The spinning of the turntable adds extra spatial motion to the otherwise plain vertical movements.

Vertical motion of the ride is powered and controlled with hydraulic system. Thus passengers are able to have a smoothly thrilling ride experience.

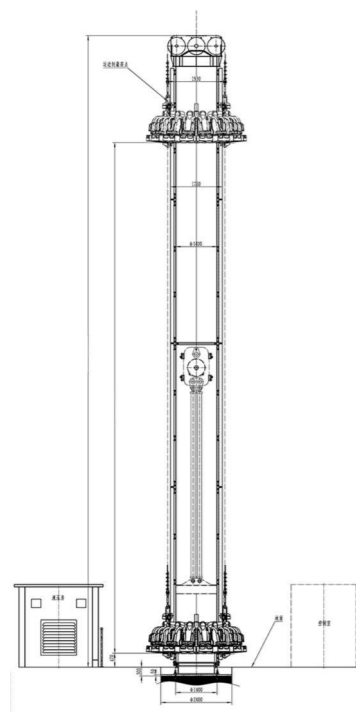
QWT-12D comes with a seating capacity of 12 people with each seat fitted with a shoulder restraint device.



 Ride Height 15.4m	 Run Speed 8.5m/s	 Revolution Speed 6rpm
 Load 12p	 Area 14.3m×8.7m	 Installed Capacity 88kVA





Fantasy Tower XYT-32D

Fantasy Tower is a wonderful family ride for a complex park. It covers a small footprint yet with a high load capacity of 32p.

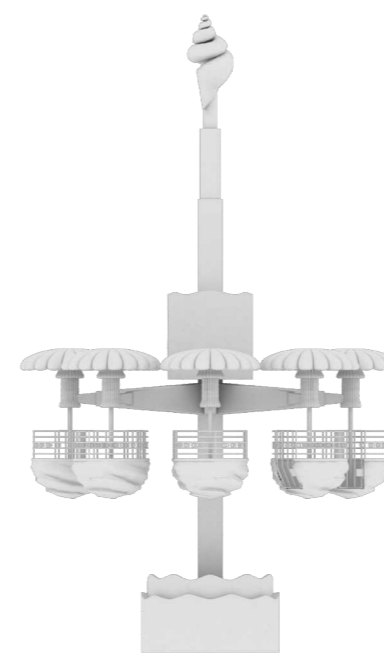
The tower is 14 meters tall. It has 8 suspended cabins. Each cabin loads up to 4 family members.

Passengers can get tons of fun from this ride, experiencing the thrill of being rapidly lifted and spun.



 Running Height 8.4m	 Revolution Speed 6.5rpm	 Rotating Diameter 7.7m
 Load 32p	 Installed Capacity 60kVA	



04

Carousels

- Carousel
- Tea Cups



Carousel DW-108A

DW-108A carousel is a luxury classic ride with a load capacity of 108 persons.

Heavily decorated to project an air of royalty, it is loved and regarded as a gateway to a realm of innocence, joy and love.

She's from a world / Of popcorn and candy / Pony rides for a dime / Little children laughing...

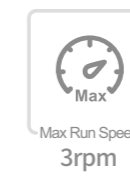

Max Run Speed
3rpm



Deck QTY
Single Deck



Turntable Diameter
19m



Load
108p

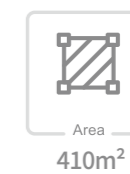

Area
410m²

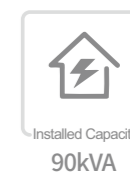

Installed Capacity
90kVA



Carousel DW-72B

DW-72B carousel is a luxury classic ride with a load capacity of 72 persons. A turntable measured at 15.6m in diameter is fitted with 60 elaborately crafted horses and 2 chariots.

Heavily decorated to project an air of royalty, it is loved and regarded as a gateway to a realm of innocence, joy and love.



Ride Height
9.5m



Deck QTY
Single Deck



Turntable Diameter
15.61m



Load
72p



Area
φ19m



Installed Capacity
80kVA

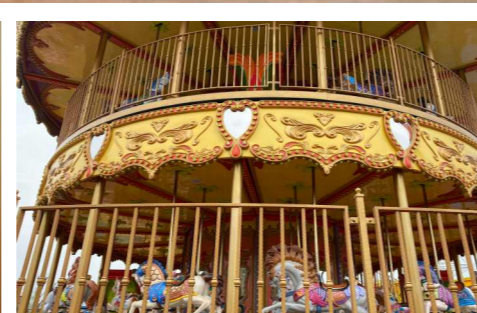

Carousel DW-88A

DW-88 carousel is a large double-deck ride with each deck running on its own course. Heavily themed in royal style, the carousel is meant to deliver the ultimate merry-go-round experience to fun-loving kids and romantic lovers.

With sophisticated theming and decoration, it looks just so serious and expensive.

This classic family ride is fitted with colorful Led lighting. When night falls, it is a sore in the eye and an island in the dream.



Ride Height
17.8m



Deck QTY
Double Deck



Turntable Diameter
12m



Load
88p



Area
φ18m



Installed Capacity
35kVA

Carousel DW-68A

DW-68 is a scaled-down version of the double deck carousel DW-88A. Heavily themed in a royal style, it is meant to lead passengers into a realm filled with innocence, joy and romantic love.

The carousel stands 14 meters tall, consisting of two platforms decked up. Those two platforms operate independently and rotate in opposite directions. A curved steel staircase leads up to the second floor.

The carousel is designed to seat up to 68 persons with an hourly capacity of more than 1,000 persons.



Ride Height
14.2m



Deck QTY
Double Deck



Turntable Diameter
10m



Load
68p



Area
φ16.3m



Installed Capacity
25kVA



Carousel DW-48B

DW-48B is medium-sized ride populated with 40 horses and 2 chariots. Themed and decorated in a way to fit the park theme, it delivers an enchanting experience that kids crave for. The vertical motion cycles combined with platform rotation produce rounds of horse gallops.

A must-have ride that kids would cry for a ride of it!

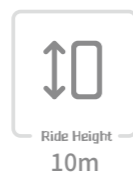

Ride Height
10m



Deck QTY
Single Deck



Turntable Diameter
16m



Load
48p



Area
φ18.2m

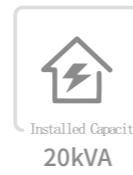

Installed Capacity
20kVA



Carousel DW-38A

DW-38A is a small-sized carousel ride. Heavily themed in the royal style, it is meant to deliver the ultimate merry-go-round experience to fun-loving kids, friends and lovers.

The carousel is fitted with 30 elaborately crafted horses and 2 chariots. When fully loaded, it accommodates up to 38 passengers.

The ride's cycle period can be set at either 2 minutes or 3 minutes, depending on the size of the park visitation.

Fitted with Led lighting, it is more luring when switch is no at nighttime. DW-38A is suitable for small/medium parks or similar venues.

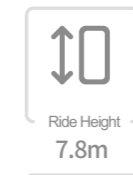

Ride Height
7.8m

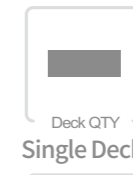

Deck QTY
Single Deck



Turntable Diameter
9m

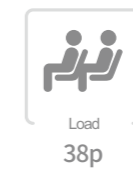

Load
38p

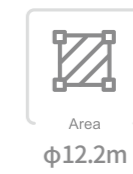

Area
φ12.2m

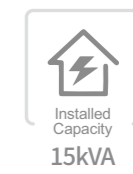

Installed Capacity
15kVA

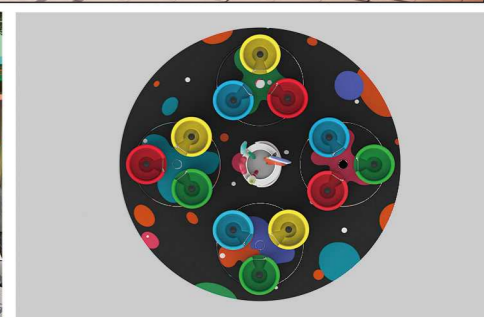

Tea Cups ZB-60B

ZB-60B consists of one major turntable with a diameter of 14.4m and four minor ones. 3 cup-shaped cabins are mounted on each minor turntable. With each cabin for 5 persons, It can load up to 60 passengers in total.

This teacup ride integrates 3 types of motions: rotation of the major turntable, spinning of the minor ones, and cabin rotating controlled by the passengers using the steering wheel located at the center of each cabin.

It is a great family ride for large park owners.

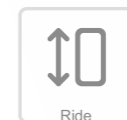

Ride Height
5m



Max Running Speed
4rpm (Large Turntable)



Load
60p



Rotating Diameter
14.4m (Large Turntable)

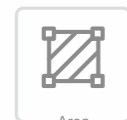

Area
φ22m



Installed Capacity
55kVA



Tea Cups ZB-36A

This lovely ride consists of one major turntable and three minor turntables on which nine cup-styled cabins are mounted. Each cabin accommodates 4 persons. The ride loads up to 36 persons in total.

The teacup ride integrates 3 types of motions: rotation of the major turntable, spinning of the minor ones, and cabin spinning controlled by passengers using the steering wheel located at the center of the cabin.

Fun and exciting, it is a perfect family ride for park owners.



Running Height
2m



Disc Diameter
Φ10.5m



Diameter of small turntable
Φ2.6m



Load
4p/cup × 9



Area
15m × 13m



Installed Capacity
25kVA

Wonder Dancing CXC-36B

Wonder Dancing, a mesmerizing rotating ride, begins after passengers securely fasten safety bars. The large disk spins clockwise while the small one counter-rotates, creating a harmonious three-minute journey. Comfortable and rarely inducing dizziness, it appeals to all ages. Themed around desserts, with dazzling lights and romantic motifs, it offers a dreamy, joyful experience.

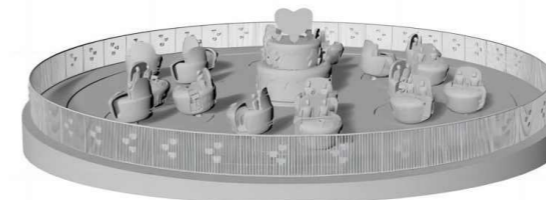

Running Height
3.8m



Rotating Diameter
13.4m



Max Run Speed
6.7m/s



Load
2p/cup × 18



Area
Φ18m



Installed Capacity
80kVA



Tea Cup ZB-18A

ZB-18A is a small Tea Cup rides available for 18 rides, there are 6 small cups installed on a big turntable, each individual cabin(cup) spins and can be controlled by passengers using the steering wheel located at the center of the cabin.

Fun and exciting, it is a popular family ride to install for park owners.

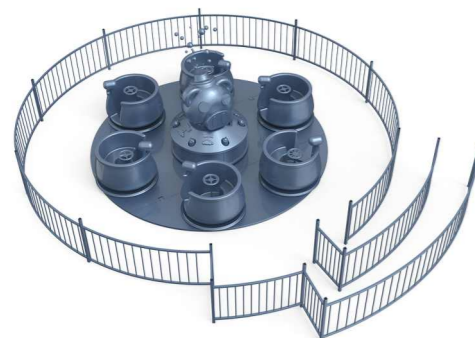

Ride Height
1.8m



Max Run Speed
4rpm



Load
18p



Rotating Diameter
5.2m



Area
60m²



Installed Capacity
3kVA



Naval Battle HZ-24A

A dual-zone amusement ride themed after maritime clashes. A central lighthouse rotates six vibrant cups, which spin alternately clockwise and counterclockwise. Removable acrylic panels between cups and railings adapt to various scenarios. Each cup houses four water guns, while six more outside let spectators join in, intensifying the battle amidst swirling motion for unparalleled excitement.

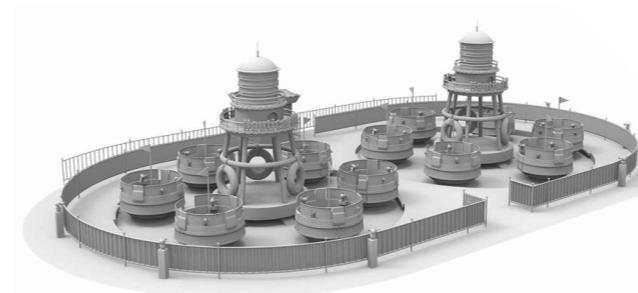

Ride Height
5m



Rotating Diameter
10.1m



Max Run Speed
1.9m/s



Load
24p



Area
8m × 14m



Installed Capacity
26kVA

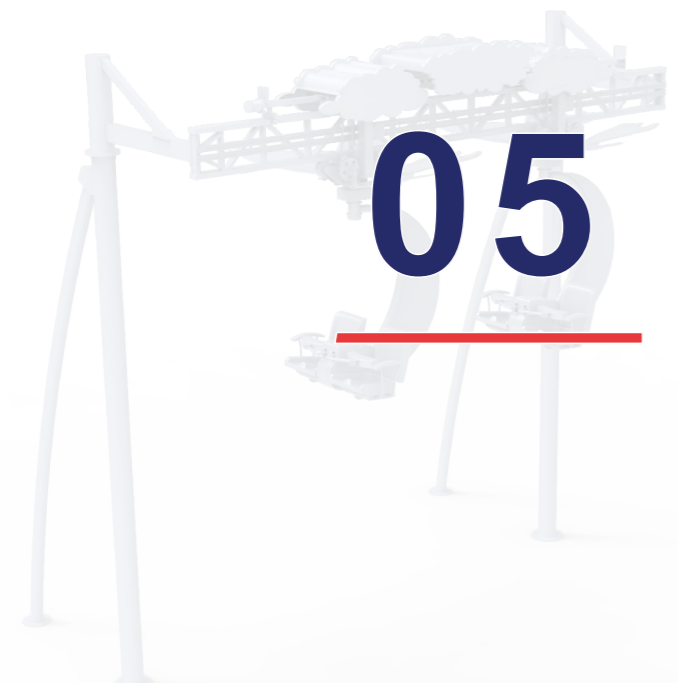

Sightseeing Series

- Scenery Train
- Suspended Monorail



Scenery Train GJC-20A

The Scenery Train is a tourist tram that operates along an elevated, electrically powered track. Featuring an open-air carriage design with a unique canopy shape, the entire tram exudes luxury and elegance, offering expansive views. The train can accommodate up to 20 passengers, boasting a large carrying capacity and operating at a smooth and moderate speed, making it suitable for visitors of all ages.

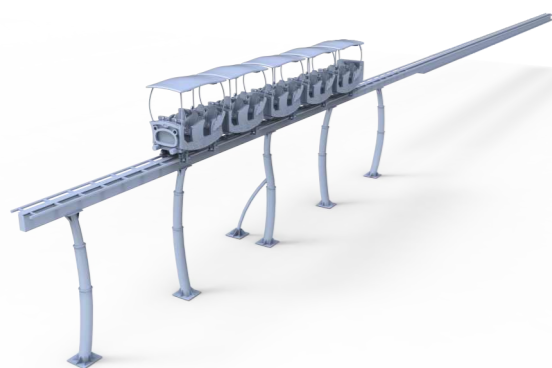

Track Height
4.86m



Max Run Speed
4.0km/h



Load
20riders/train × 2



Area
Depends on
the number of
vehicles on site



Installed Capacity
10kVA

Suspended Monorails XYC-4B

A lovely ride, isn't it?

When you board such a ride, you better have your loved one beside you. Because it is so bonding. The butterfly vehicle carries you two in a steady and controlled pace along an overhead trackway while the wings over your head flutter all the way along. If you are naughty, pull the handle, give the car a little swirl and hear out your partner holler.

Vehicles are suspended below the elevated trackway. Each vehicle accommodates 4 persons. Track layout and vehicle quantity can be customized.



Ride Height
6.4m



Running
Height
3.4m



Load
4 riders/vehicle



Installed
Capacity
≥ 40kVA
Depends on
the number of
vehicles on site



06

Classic Rides

- Armor Rides
- Super Swing
- Go-go Bouncer
- Space Shuttle
- Frisbee
- Viking



Viking HDC-56A

This classic pendulum consists of a tower structure made of four columns, a pair of swing arms, and a gondola.

The gondola is suspended onto the top of the tower via swing arms. When the ride is in operation, it swings back and forth to a max 60 degree, enabled by the propulsion tyre mounted on the center of the ground just above the middle line along the bottom of the gondola.

Restrained by lap bars on each row, safe and sound, passengers are able to experience a significant amount of airtime.

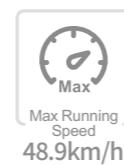
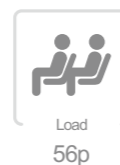
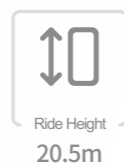
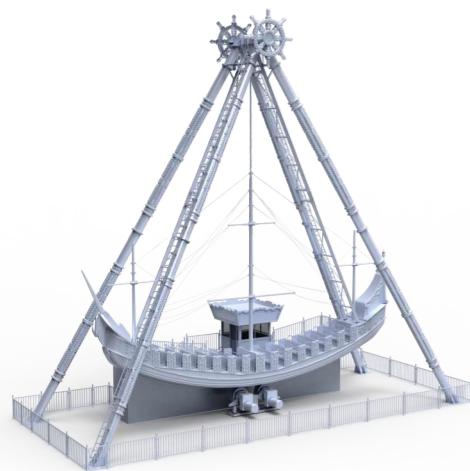

Viking HDC-24A

Standing 9m tall, this classic pendulum ride consists of a tower structure consisting of four columns, a pair of swing arms, and a 24-seat gondola.

The gondola is suspended onto the spindle located at top of the tower via swing arms. When the ride is in operation, the gondola swings back and forth up to an angle of 60 degree max. The propulsion is powered by the motor-driven frictional tyre mounted on the center of the ground just above the middle line along the boat bottom.

Restrained by lap bars on each row, safe and sound, passengers are able to experience the thrills that a swing gondola brings.

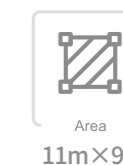
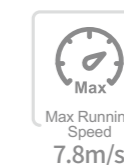
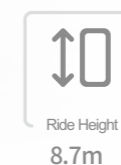
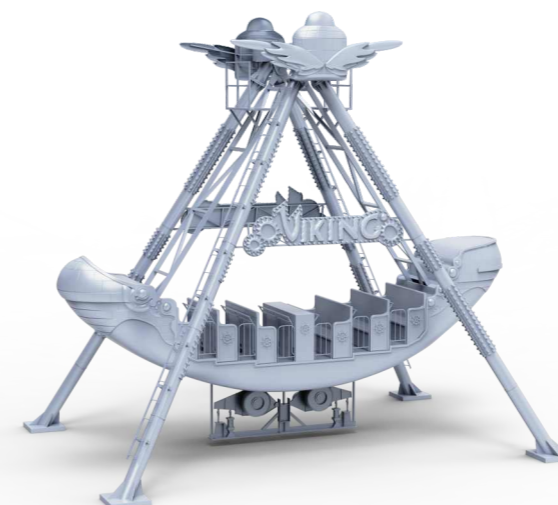



Frisbee DBC-30B

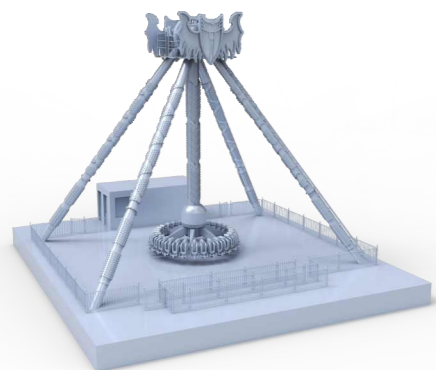

Frisbee is a giant pendulum ride that swings the riders up to 24 meters high. Secured in seats on the carousel, riders are able to experience a combined motion of spinning and swinging. The sensations are just overwhelming.

This pendulum ride comes with 30 seats mounted around on the carousel. Each seat is fitted with a shoulder restraint to keep the rider safe in place. It is able to swing up to an angle of 120 degree and suspend passengers at a highest point for 1second or 2 and then sweeps all the way down.

It is a classic stimulating ride that visitors hold dear.

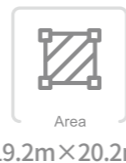
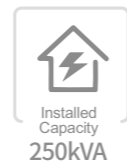
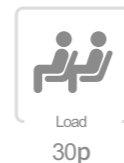
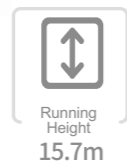

Crazy Bus SBF-18A

SBF-18A is a ride similar to SBF-24A. The vehicle features a themed bus with 18 seats in 6 rows.

Guests on board the ride face sideways in the direction of the rotation.

Little kids love this kind of rides.

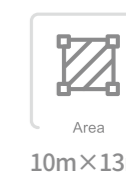
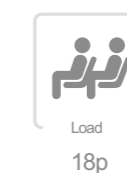
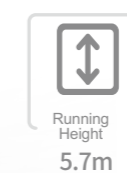

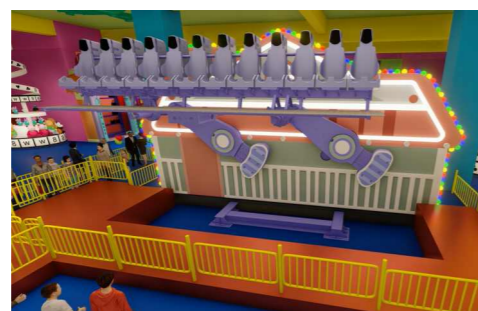
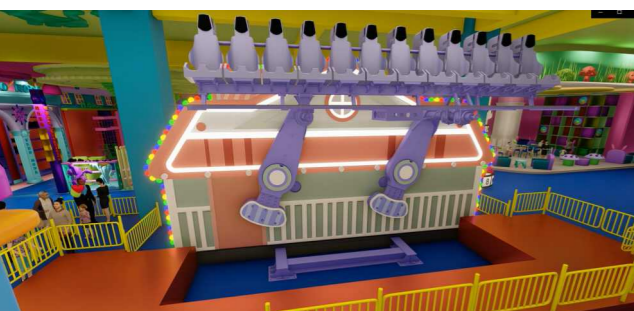

Crazy Surfing SBF-12A

Crazy Surfing, a DC motor-driven thrill ride, features arms propelling a cabin in a blend of rotation and translation, tracing circular paths like sea waves. Riders inside enjoy alternating spins, mimicking surfing thrills with a gentle breeze adding freshness. At night, its colorful exterior and changing lights transform it into a fashionable, captivating attraction.

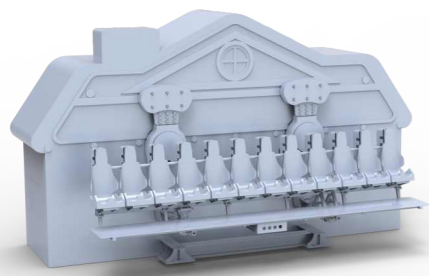

Running Height
4.2m



Load
12p



Area
8.3m×13.3m



Installed Capacity
60kVA

Magic Flying HY-24A

Magic Flying offers a refreshing and nostalgic experience that resonates with childhood memories. The spacious cabin comfortably accommodates both children and adults, equipped with 12 handrails. The bottom of the paper airplane is adorned with child-themed graffiti. Passengers can control the paper airplane by pulling and pushing triangular levers in front of them. Additionally, a central hydraulic system ensures balance, allowing the airplane to maintain stable flight regardless of passenger control.



Rotating Diameter
12.7m



Max Run Speed
8rpm



Running Height
4.4m



Load
24p



Area
φ17.27m



Installed Capacity
65kVA

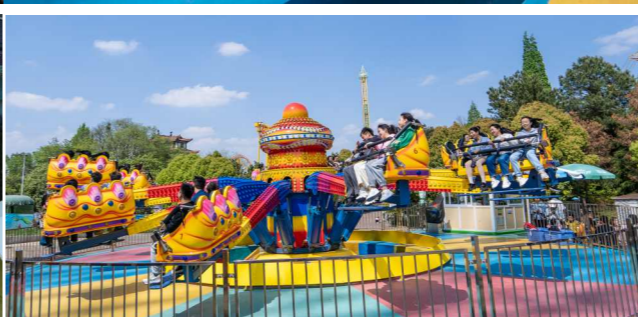

Go-go Bouncer TT-42A

Go Go Bouncer is a star ride in a park. In contrast with other similar round rides which move the arms (cabins) up and down in a rather rigid or mechanical way, our ride literally bounds cabins up as if passengers were sitting on a huge suppressed spring.

It comes with 14 cabins, each holding 3 persons. Passengers are secured via. shoulder restraints. When the ride is in operation, passengers rotate around the center while springing up and down, creating an illusion that they are bounding forwards.

It is a popular ride with both kids and adults, thrilling and lots of fun.

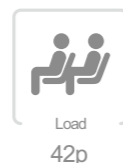
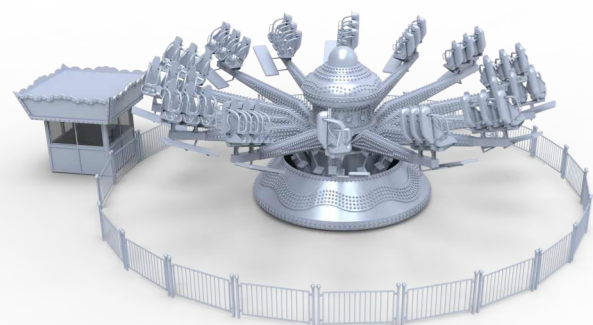

Go-go Bouncer TT-36B

Go Go Bouncer TT-36B is the cousin of TT-42A with 12 arms. It has the load capacity of 36p. In contrast with other similar round rides which move the ride's arms (cabins) up and down in a rather rigid or mechanical way, Go Go Bouncer literally bounds cabins up as if passengers were sitting on a huge suppressed spring.

Passengers are secured via. shoulder restraints. When the ride is in operation, passengers rotate around the center while springing up and down, creating an illusion that they are bounding forwards.

Popular with both kids and adults, you may want to have one at your park.

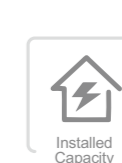





Space Shuttle ZK-64B

Space Shuttle is an interactive round ride. As the ride rotates, passengers in the cabin may work on the console to control the cabin movement in the vertical direction. Sensation intensifies when a constant change in altitude is introduced.

A cabin is mounted on the far end of each swing arm. The up-and-down movements of swing arms is driven by pneumatic power. There are total 16 cabins, with each cabin holding up 4 passengers. All the arms are connected to a central carousel which is motor-driven to rotate on its own axis.

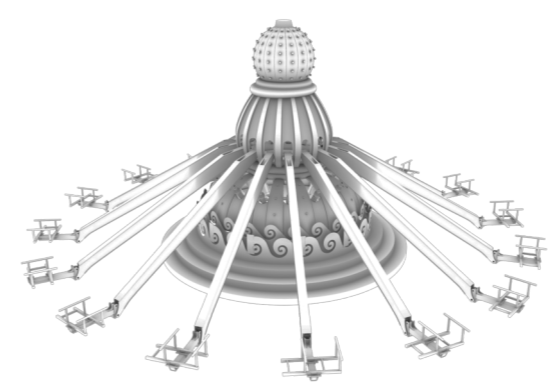
It is a family ride that is meant to bond, suitable for parks of any size.





Ride Height
8.8m

Load
64p

Installed Capacity
235kVA

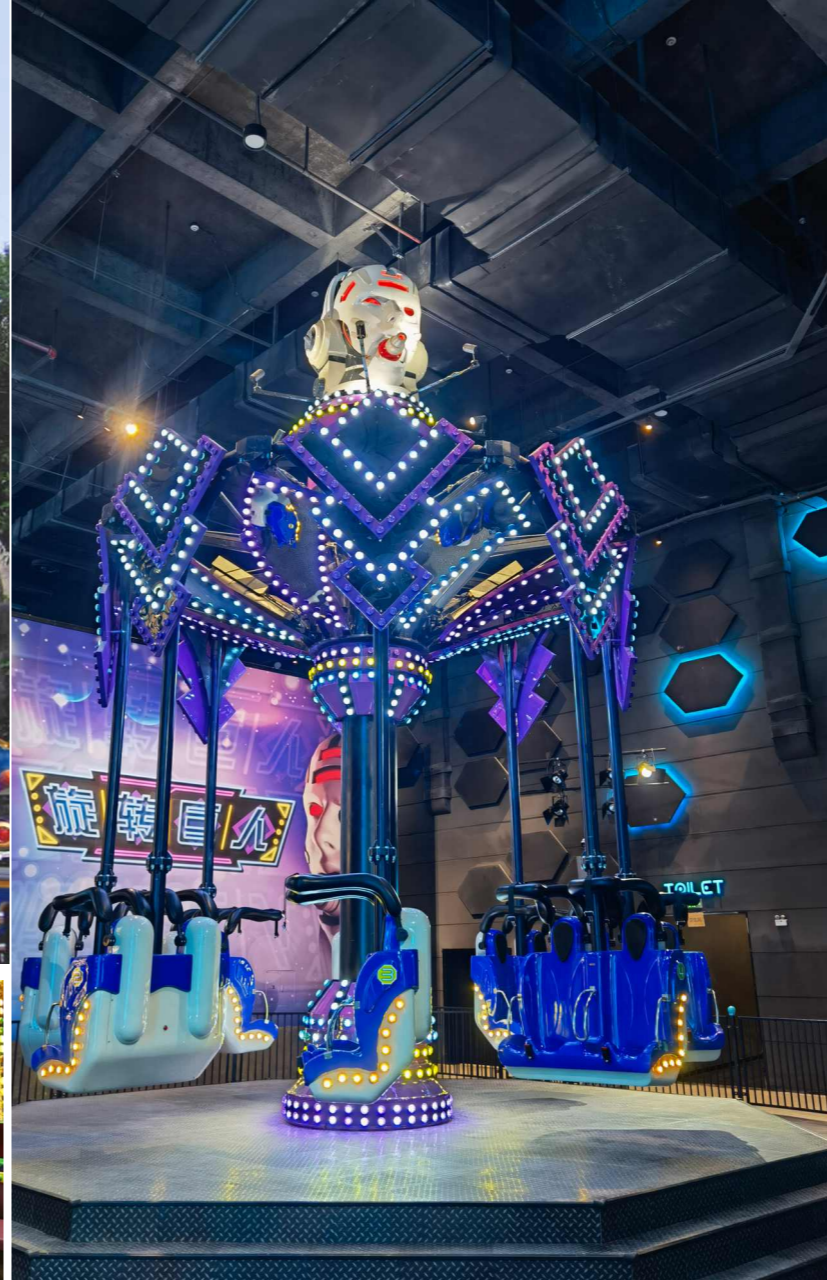
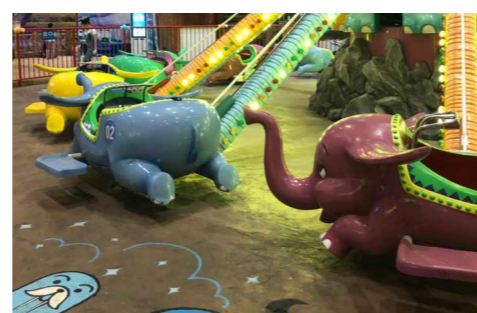
Area
φ22m



Space Shuttle ZK-24A

Space Shuttle is an interactive round ride. As the ride rotates, passengers in the cabin may work on the console to control the cabin movement in the vertical direction. Sensation intensifies when a constant change in altitude is introduced.

A cabin is mounted on the far end of each swing arm. The up-and-down movement of the swing arm is driven by pneumatic power. There are total 12 cabins, with each cabin holding up to 2 passengers. All the arms are connected to a central carousel which is motor-driven to rotate on its own axis.



Ride Height
7m



Load
24p



Installed Capacity
45kVA



Area
240m²

Twister QQ-16A

QQ-16A is a suspended round ride. 8 double cabins are suspended onto the retractable arms. During the ride, mechanism rotates and bounces the arms. Thus riders onboard experience rounds of spins and bounces.

The ride has a load capacity of 16p.

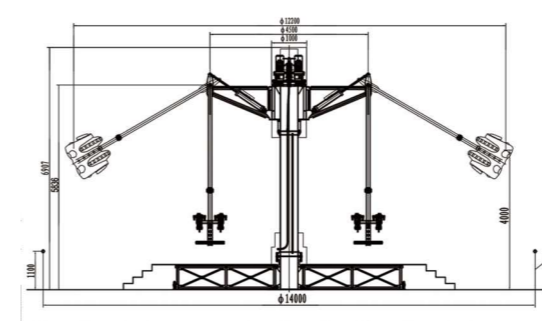

Ride Height
7.7m



Load
16p



Installed Capacity
25kVA



Area
φ14m



Super Swing FY-39A

FY-39A is a swing tower ride, 8.6m tall. The carousel rises and rotates, lifting and flinging the suspended chair seats. The seats are arranged to rotate on two orbits, with 17 single seats on the inner orbit and 11 double seats on the outer one. The ride has a large THRC of 780p/h.

It is a popular swing ride suitable for small and medium amusement parks.

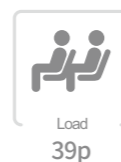

Super Swing FY-48C

Super Swing is one of the beloved swing rides. It features suspended chairs flung outwards, rotating and tilting in the midair.

The carousel rises and starts rotating. When it reaches the predefined elevation, it starts to tilt sideways, adding more dynamic to the ride motions. The ride is fitted with 48 single seats suspended to the carousel with chains.

The ride's central column is themed as a blue and white pottery vase with a multi-colored canopy on top. Thrilling and fun, it is a ride for the young and the old.

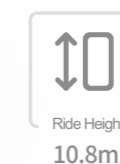

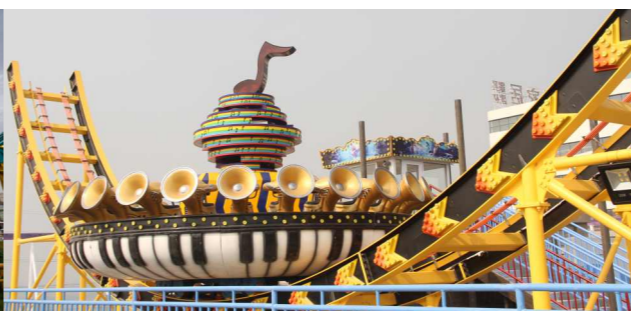

W-Disco DSG-40A

Standing 15.2m tall, this novel disco ride consists of a “W” shape track and the support, and a 40-ride giant vehicle.

The W-track makes the experience unique and different from the conventional disco ride. While riding the waves along the track, the vehicle rotates by itself and gives the riders more spatial motion.



Running Height
15.2m



Run Speed
13.5m/s



Area
89m × 16m



Load
40p



Installed Capacity
160kVA

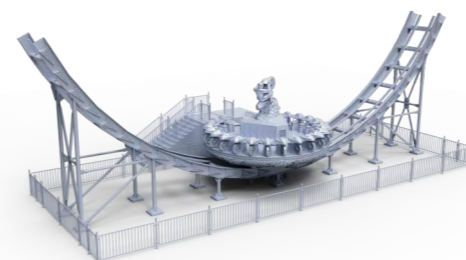

Disco DSG-24B

DSG-24B Disco is a rotated sliding rides with extremely dynamic movement, covering an area of 12.4mx23m. It is mainly consisting of body, orbit, driving device, sliding contact line, etc.



Running Height
8.6m



Area
12.4m × 23m



Load
24p



Installed Capacity
80kVA



Firing Train YKC-48C

Firing Train features a central support with slewing bearings connecting 16 rotating arms. Each arm is equipped with travel wheels, and four of them are powered. Sixteen cabins are installed between these arms. Beneath the travel wheels, a circular undulating track is laid out. Driven by the powered arms, the Flame Chariot rotates around the central star with ups and downs. While the cabins rotate with the arms, they also move up and down along the track, providing passengers with the thrill of multi-layered composite rotational movements.



Ride Height
3.4m

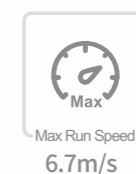

Max Run Speed
6.7m/s

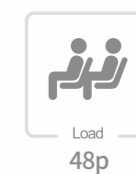

Load
48p



Rotating Diameter
11.7m

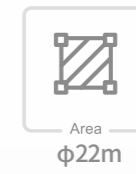

Area
φ22m



Installed Capacity
25kVA



Wonder Lantern HD-48A

HD-48A is a suspended round ride. It is fitted with 12 cabins, each carrying 4 riders. The ride's 48-seater design gives it a large capacity up to 960pph.

During the ride, the carousel slowly rises to the starting position and begins to rotate. Then the carousel together with cabins is lifted up the guide post while being rotated. When it reaches the highest point, it stays at inclination of 15°, tilting all cabins to introduce extra motion varieties.

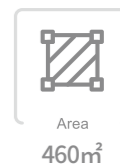
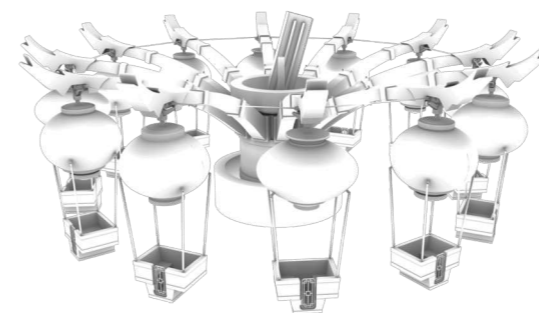



Magic Poker FY-32B

Magic Poker FY-32B is portable ride that requires no fixed foundation work. The ride is designed with 8 cabins, 4 riders each.

While the ride is rotating around the central fixture, riders can actually mess with the steering wheel installed in each cabin to spin the individual cabin.

Totally potable, FY-32B is a great selection for carnivals.



Ride Height
6.4m

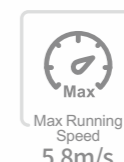

Max Running Speed
5.8m/s



Load
32p

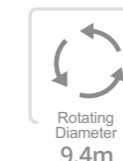

Rotating Diameter
9.4m



Area
φ13.7m



Installed Capacity
50kVA



Robot Armor FBJ-12A

This Robot Armor has cool appearance of robot mech and runs by the rotation of the robot's two swing arms. 6 riders can be seated at each arm. The ride has a novel appearance, rich operating elements, and attractive lighting, making it an eye-catching attraction in the park.



Running Height
1.5m



Revolution Speed
4rpm



Load
12riders



Rotating Diameter
5.6m



Area
10m×9.1m



Installed Capacity
10kVA



Lobster Armor JQJ-16A

Inspired by lobster, JQJ-16A is designed with the cool appearance of mechanical lobster shape and bionic mech giant pincers. Rising to the designed height, the pincers will move in a vivid way that a lobster does. Each pincer is with a capacity of 8 seats, totally 16. The novel appearance, rich operating elements and lighting effects make it an eye-catching star attraction in the park.

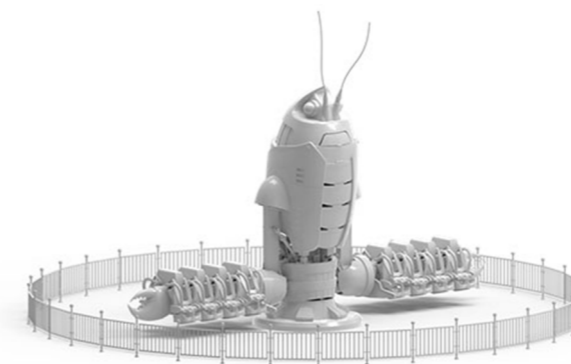

Running Height
4m



Revolution Speed
9.5rpm



Load
8riders X 2



Rotating Diameter
7.5m



Area
φ11.8m



Installed Capacity
50kVA

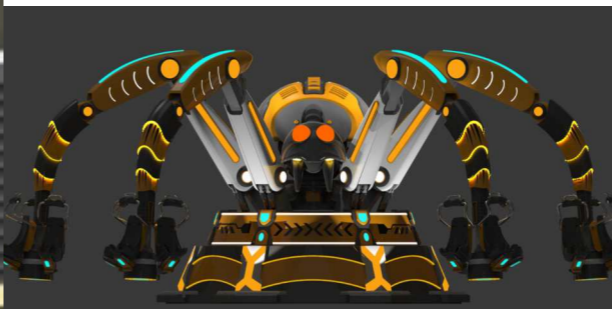
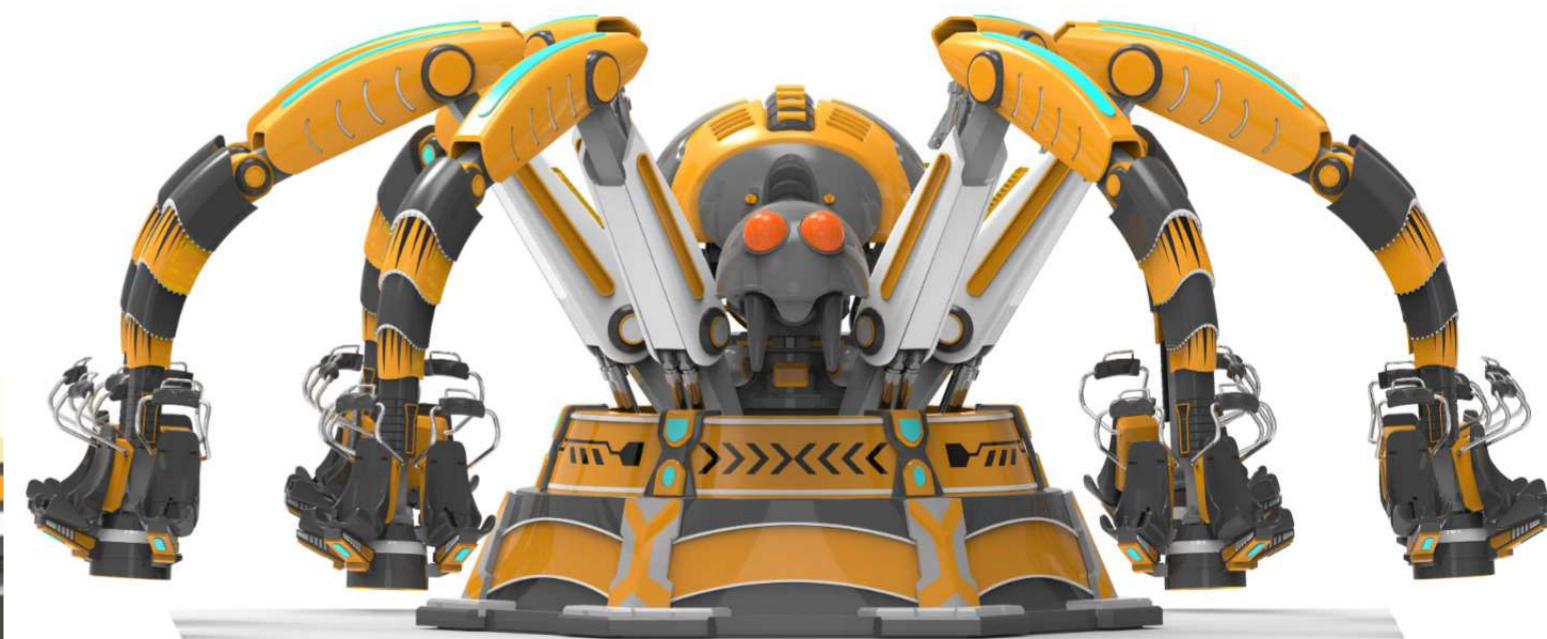

Spider Armor ZZJ-24A

The design inspiration for Spider Armor comes from spiders! It is a new development of Jinma Rides which has cool appearance of the bionic mech spider, eight cantilevered spider-like legs, each of which is available for 3 riders.

With its novel appearance and rich operating elements, Spider Armor can be an eye-catching star ride for indoor or outdoor parks.

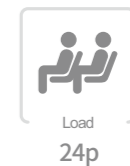
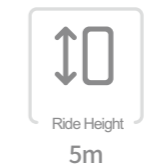

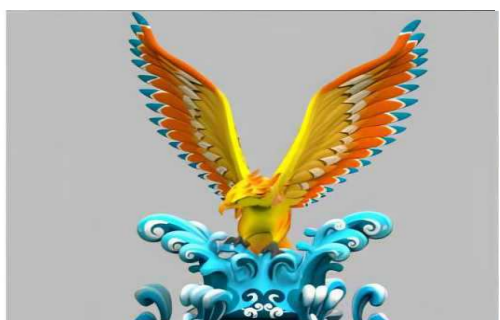









Flying Roc TL-48A

Inspired by the roc, the TL-48A simulates the soaring experience of the bird as it spreads its wings. Passengers seated in the cabin are treated to an exhilarating ride as the equipment rotates, embarking on a fantastic journey accompanied by the roc.



 Running Height 6.8m	 Revolution Speed 5rpm	 Ride Height 9.7m	 Rotating Diameter 13.6m
 Dip Angle 45°	 Load 48riders	 Area Φ17.6m	 Installed Capacity 140kVA



Dancing Parrot TL-24A

With the cute theme of Parrot, TL-24A is a novel family ride where passengers will experience the thrills of rotation in a level and tilting way. It consists of one big turntable, well-designed seats, and support arm.

Accompanied by parrot, passenger can enjoy a pleasant riding experience!



Running Height
6.4m



Revolution Speed
4rpm



Load
24riders



Max Run Speed
4.3rpm



Area
φ11.9m



Installed Capacity
50kVA



Kiddie Rides

- Bumper Cars
- Fire Brigade
- Jumping Frog
- Dancing Party
- Swing Fruit
- Bumble Bee
- Jellyfish



Bumper Cars PPC-106A

Bumper cars are always popular in an amusement park. The thrill that a car collision delivers just feels indescribably great.

PPC-106F is designed to work with a floor pick-up system. In a floor pick-up system, the power supply is fed to a bumper car via flooring material only.

A classic amusement ride for both young and old, the bumper car facility can be built indoor or outdoor. Flooring can be customized as the site layout requires.

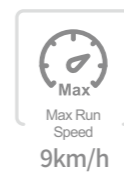



Tractor TLJ-4A

The Tractor is a type of small train-like equipment themed after the realistic design of a tractor. The vehicle boasts a cool appearance with vibrant colors, and its interior is modeled after an actual tractor. Children can experience the feeling of driving a tractor by playing with components such as the steering wheel and manual levers, enriching their cognitive abilities and enhancing the fun of sightseeing. Each vehicle is equipped with four seats, with the front row designated for children and the back row for adults. As the tractor weaves through the scenic landscapes of the beautiful attraction, families can enjoy the beautiful scenery while sharing joyous moments together.



Run Speed
1m/s



Track Length
355m



Load
4 p/car



Ride Height
2.5m



Area
49m×106m



Installed Capacity
55kVA



Waving Train BLC-45A

BLC-45A is a novel amusement ride designed for family with kids. With 1.3 meters running high, its cute-themed train goes up and down around the circular track, allowing passengers to enjoy a pleasant riding experience.

Fixed or foundation-free, It covers a small area but contains great fun! It can be a perfect choice for outdoor parks, indoor parks, FECs and carnival events!

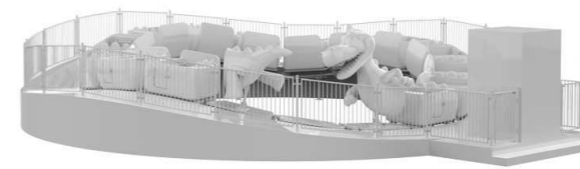

Running Height
1.9m



Revolution Speed
1.9m/s



Load
3riders/trainX15



Ride Height
1.3m



Area
Φ14m



Installed Capacity
20kVA



Wild Truck KC-24A

With off-road vehicle as the theme, Wild Truck KC-24A is a novel ride popular with children, teens and families. The combination of ragged theming, huge tires and metal shell makes the ride unique, and enables the riders to feel what it feels driving their very own vehicle like there was no tomorrow.

It is a mobile amusement ride with no fixed foundation work required.

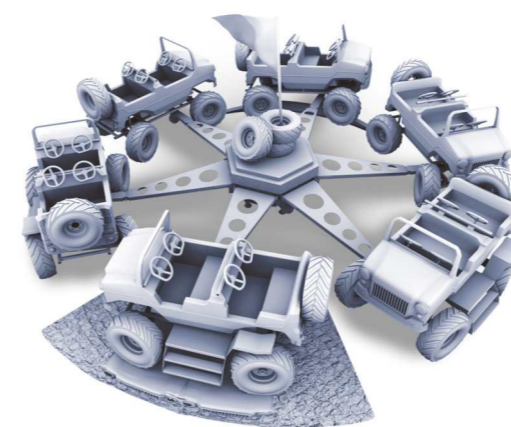

Ride Height
3.2m

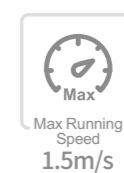

Max
Running
Speed
1.5m/s



Load
24p

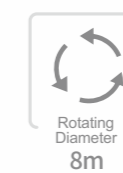

Rotating
Diameter
8m



Area
11m x 12.5m



Installed
Capacity
15kVA



Jellyfish SM-32A

Jellyfish is a very great round ride in terms of motion diversity and combination. Taking this ride, you are able to experience upward lifting, rotation, spinning and variable tilting.

When the ride is in operation, the lifting system elevates the central carousel fitted with cabins to a designed elevation while the carousel rotates around the central FRP figure. A steering wheel is installed in each cabin, which passengers may want to work with to spin the cabin.

Colorfully themed, it is a ride attraction that draws young and old.

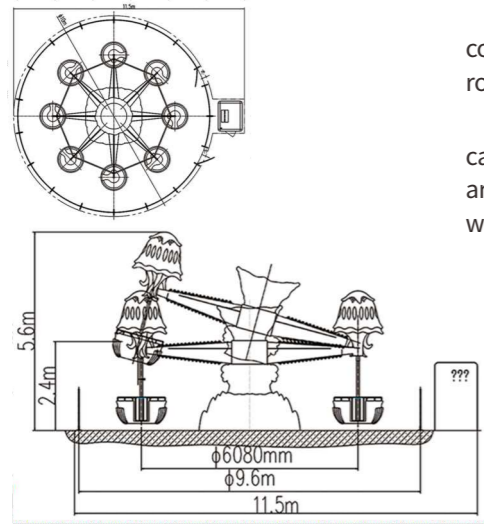

- Running Height 2.4m
- Load 32p(kids) or 8p(adults)+16p(kids) (Cabin load<160kg)
- Installed Capacity 12kVA
- Area $\phi 11.5\text{m}$ (Including fence)

Starfish Jets TT-16A

Starfish jet is an 8-armed round round. Each arm is fitted with a 2-seater cabin. Themed as bright-colored marine life, it is a popular ride for kids and families. With shoulders restrained, passengers on board start to rotate around the centerpiece while bouncing up and down. The bouncing motion is powered via the pneumatic system.



- Ride Height 5.1m
- Load 16p
- Installed Capacity 35kVA
- Area 17m X 13m

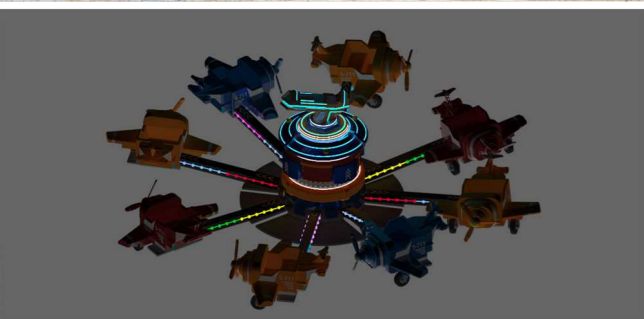

Space Shuttle ZK-16H

Space Shuttle ZK-16H is an interactive round ride. As the ride rotates, passengers in the cabin may work on the console to control the cabin movement in the vertical direction. Sensation intensifies when a constant change in altitude is introduced. There are total 8 cabins, with each cabin holding up 2 passengers. All the arms are connected to a central carousel which is motor-driven to rotate on its own axis.

It is a family ride that is meant to bond, suitable for parks of any size.

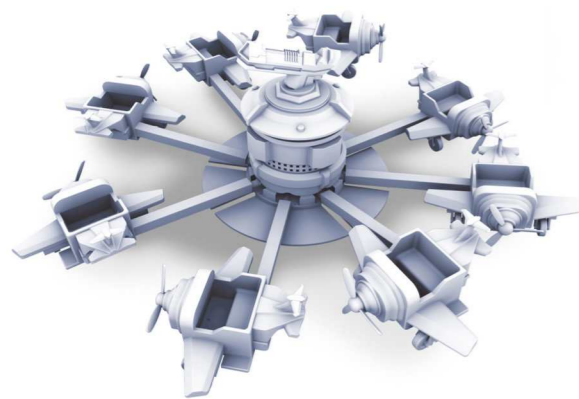

Running Height
1.9m



Max Run Speed
1.9m/s



Load
16p



Rotating Diameter
7.7m



Area
φ12m



Installed Capacity
15kVA



Swing Fruit FY-16A

Fruit Swing is a lovely tower swing ride for little kids. As the tower rotates, 16 watermelon-themed cabins go around the tower and spread outwards. The cabins are suspended onto the canopy of the tower via steel chains.

It is a thrill ride for little kids.

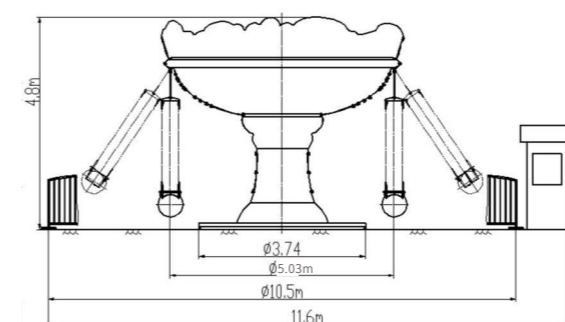

Ride Height
4.8m



Load
16p (kids)



Installed Capacity
6kVA



Area
φ11m



Jumping Dolphin QWT-8B/D

Based on the theme of dolphins jumping in the ocean. It comes with a single seating bench for 8 persons. The ride stands 8.5 meters tall with a working level of 4.4 meters. When it is in operation, the pneumatic system drives the gondola to bound up and down, simulating jumps that a Dolphin makes.

It is designed for little kids between 1-1.3m in height. It is a fun and thrilling ride for our little riders

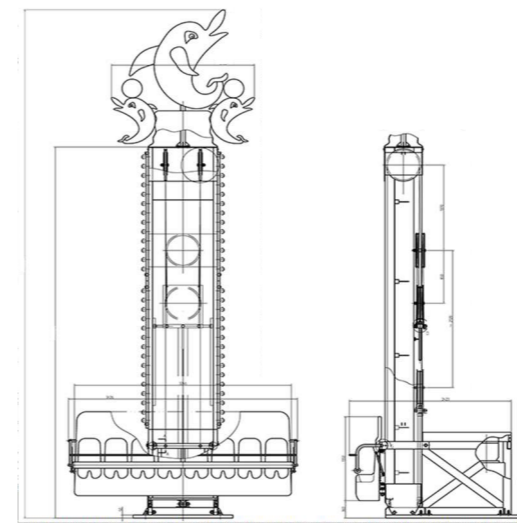

Ride Height
8.5m

Load
8p (kids)

Installed Capacity
10kVA

Area
5.3m × 6.3m